

Good. Safe. Klingspor.

Price List 2019



5

We rank amongst the world's five leading manufacturers of abrasives.

1893

Klingspor was founded as a family owned business.

More than

five hundred

qualified technicians and sales representatives offer professional on-site assistance

300 million

euros in sales during the past year.

Over

50 thousand

items in our product range.

Every day Klingspor produces:

110,000

abrasive mop discs.

350,000

cutting-off wheels and grinding discs.

One hundred thousand square metres

of coated abrasives.

2,900

employees are hard at work everyday to keep our customers satisfied.

General information

Contents 3

Coated abrasives

Product overview 4-7
Applications guide 8-11

Abrasive flap discs

Applications guide 88-93
Abrasive flap discs 94-97
Non-woven web wheel 98
Cleaning wheel 99



Rolls

Rolls with paper backing 12-15
Rolls with cloth backing 15-16
Non-woven web rolls 17



Cutting-off wheels

Applications guide 100-109
Cutting-off wheels 0,8-1,0 mm 110-113
Small cutting-off wheel 114
Cutting-off wheels 1,6-1,9 mm 115
Cutting-off wheels 2,0-3,2 mm 116-119
Large cutting-off wheels 120-123



Belts

File belts 18-19
Short belts for hand held machines 20
Belts with paper backing 21-22
Belts with film backing 22
Belts with cloth backing 22-28
Non-woven belts 28
Abrasive sleeves 29
Rubber drums 29



Grinding discs

Applications guide 124-125
Grinding discs 126-129



Wide belts

Wide belts with paper backing 30-32
Wide belts with cloth backing 33-37



Diamond tools

Applications guide 130-135
Diamond cutting blades 136-139, 142-145
Diamond cup grinding wheels 140-141



Diamond drill bits & other diamond tools

Diamond drill bits 146
Adapter 141
Reduction rings 145

Fibre discs

Applications guide 38-41
Fibre discs 42-46
Backing pads 46-47
Dispenser 47



Flexible abrasives

Flexible abrasives 147



Strips/sheets/discs

Strips/sheets

Sheets with paper backing 48-50
Strips with paper backing, self-fastening 51
Non-woven web pads, abrasive block/spoge 52-54

Discs

Applications guide 56-57
Discs with paper backing, self-fastening 58-65
Non-woven web discs 66
Backing pads 65, 66, 67



Carbide burs

Applications guide 148-151
Carbide burs 152-155



Quick Change Discs

Quick Change Discs 68-69
Backing pads 70
Adapter 70



Retail range

Applications guide 156-157
Retail range 158-163



Abrasive mops

Applications guide 72-77
Abrasive mop wheels 78-81
Satin finishing drums 82-83

Small abrasive mop

Applications guide 84-85
Small abrasive and mop 86-87
Finishing mop 87



Service

Point of sale 164-165
Safety recommendations 166-167
Terms and Conditions of Trade 168-169
oSa 170

The product groups at a glance

With this catalogue, Klingspor makes it quick and easy to select the products you need from our huge range of top quality abrasives. The clear and logical layout in eleven product groups makes it easy for you to find what you are looking for.

State-of-the-art manufacturing techniques ensure that our coated abrasives fulfill the most demanding standards of surface finish, long life and stock removal.



Belts

Klingspor abrasive belts are available in various sizes and grades to meet all sanding and grinding requirements for a wide range of materials and applications.



Fibre discs

Klingspor fibre discs are exceptionally suited for rough grinding work, derusting metal parts, deburring and working on welded seams.



Rolls

Klingspor rolls for hand sanding or use with handheld machines are available in a number of special grades designed for a wide variety of materials – from wood, to metal, to paint.



Abrasive strips, sheets and discs

Klingspor strips, sheets and discs are available in various qualities and designs.



Abrasive mop wheels

The abrasive mop wheel is particularly suitable for finishing where flexibility is a must. It matches the contours of any workpiece perfectly. Klingspor has the right abrasive mop wheel for virtually every application and for nearly all types of material.

General information

Product overview



Abrasive mop discs

The performance of the Klingspor abrasive mop disc, with its fan-shaped radial arrangement of the cloth grinding flaps, far exceeds that of other abrasive products.



Kronenflex grinding discs and cutting-off wheels

Continuous innovation and the development of specialised products for all application areas enables Klingspor to offer a range of grinding discs and cutting-off wheels to satisfy every need.



Retail range

The complete range available with relevant grit ranges and assortments in customised packing units. Uniform packing design with precise product identification for quick access.



Flexible abrasives

Flexible abrasives which were developed by Klingspor for precision finishing and polishing work on all kinds of surfaces.



Carbide burrs

Klingspor carbide burrs are manufactured according to the highest quality standards and with utmost precision. The different cuts are adapted to meet the specific requirements of various materials and applications.



Diamond tools

Klingspor's comprehensive range of diamond tools makes it easy for any user to work faster and with greater precision and endurance. As they are made of carefully tested premium grade materials, the products included in each product line offer a wide range of possible applications and meet the highest safety standards.

General information

Product overview



Hand sanding

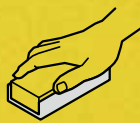

Hand block



Orbital sander



Random orbital sander



Delta sander



Portable belt sander

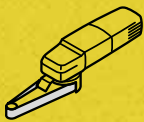

Hand tool belt grinder

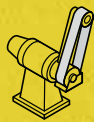

Back stand grinding machine

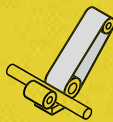

Centreless finishing machine



Through-feed grinding machine

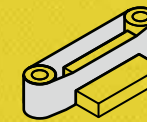

Edge sanding machine



Contour finishing machine

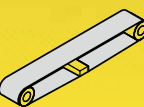

Pad / stroke sanding machine



Wide belt finishing machine

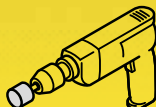

Drilling machine

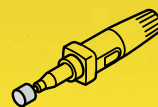

Die grinder



Satin finishing machine



Floor standing grinder

General information

Product overview



General information

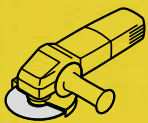

Angle grinder



Angle grinder with abrasive mop disc



Angle grinder with cup grinding wheel

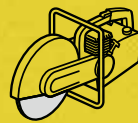

Petrol powered cutter

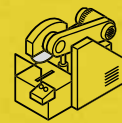

Stationary cutting machine $\leq 5\text{kW}$



Chop saw



Drilling machine



Joint cutter



Lifting beam with mottling points

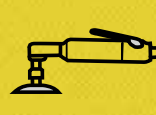

Right angle die grinder



Flexible shaft grinder

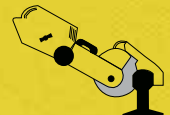

Petrol powered cutter with clamping device

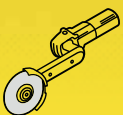

Fillet weld grinder

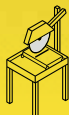
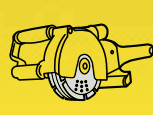

Table saw



Joint router



Stationary cutting machine $> 5\text{kW}$



Parquet Sander

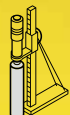

Drill stand

Coated abrasives

Applications guide

Coated abrasives are abrasive products that are made out of more or less flexible backing material upon which grit is anchored with a bonding agent. The product family “coated abrasives” includes abrasive belts, rolls, sheets, strips and discs. They comprise of the following four, optionally also five, components (please refer to the illustration on the right):

- ▶ 1. Backing
- ▶ 2. Base coat
- ▶ 3. Grit
- ▶ 4. Topsize coat
- ▶ 5. Optional: additional coating

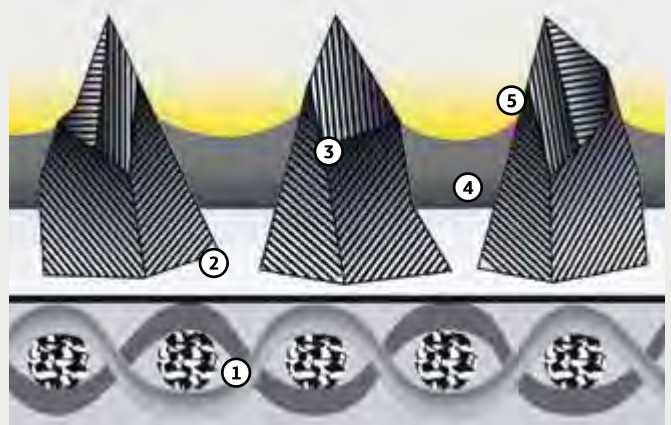

Structure

1. Coated abrasive backing

The backing is coated with grit and transfers stock removal forces onto the workpiece. The following backings are primarily used in the manufacture of coated abrasives:

- ▶ Paper
- ▶ Cotton cloth
- ▶ Polyester cloth

In addition, at Klingspor the following backings are used exclusively for individual products and/or for specific requirements/applications:

- ▶ Fibre (is used exclusively for fibre discs on portable angle grinders)
- ▶ Film (is used exclusively for the products FP 73 W and FP 73 WK)
- ▶ GX-blended cloth (special cotton/polyester blend for flexible yet highly tear resistant belts)

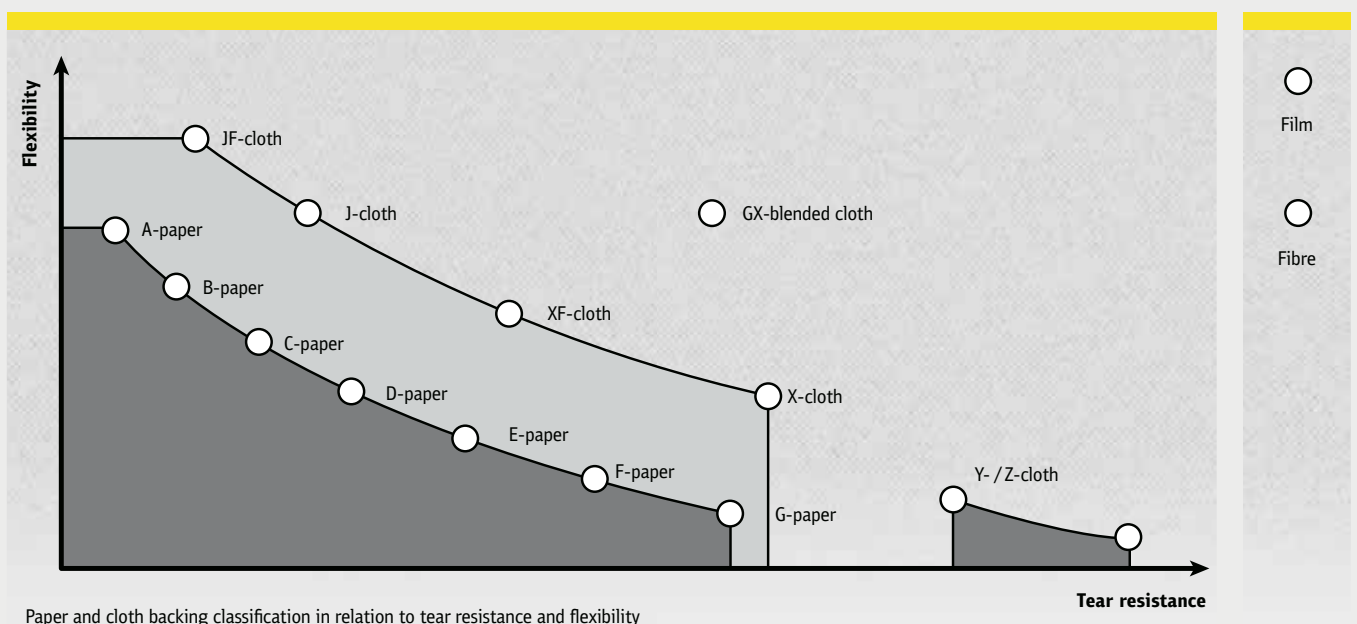

Coated abrasives

Applications guide



Backing	Description	Application examples
A – paper	approx. 95 g/m ²	profile + surface grinding (hand)
B – paper	approx. 105 g/m ²	profile + surface grinding (hand)
C – paper	approx. 110 g/m ²	surface grinding (hand)
D – paper	approx. 130 g/m ²	surface grinding (hand and machine)
E – paper	approx. 250 g/m ²	surface grinding (machine)
F – paper	approx. 300 g/m ²	surface grinding (machine)
G – paper	approx. 400 g/m ²	surface grinding (machine)
JF – cloth	light, highly flexible	high profiled workpieces (hand and machine)
GX – blended cloth	light, flexible	profiled workpieces (machine)
J – cloth	light, flexible	profiled workpieces (hand and machine)
XF – cloth	heavy, flexible	hand tool belt grinder
X – cloth	heavy, firm	surfaces, edges, rotation bodies (machine)
Y – cloth	heavy, highly firm	surfaces, edges, rotation bodies (machine)
Z – cloth	heavy, highly firm, can be segmented	surface grinding (machine)
Film	polyester film	finish grinding
Fiber	vulcanised fibre	rough and finish grinding

2. Base coat

In the base coat step the grit is anchored. The basic bond is the connection between the grit and the backing. It is primarily formed using resin, this provides it with its consistent high quality properties. Glue is only added to a few abrasive papers that are used with hand operated machines and applications.

3. Grit

Grit is responsible for stock removal. When selecting the correct grit two properties are particularly important:

- ▶ Bond
- ▶ Toughness

All Klingspor grit types are produced synthetically. This ensures a consistently high quality product. Four different grit types are used with coated abrasives:

- ▶ Silicon carbide
- ▶ Aluminium oxide
- ▶ Zirconia alumina
- ▶ Ceramic aluminium oxide

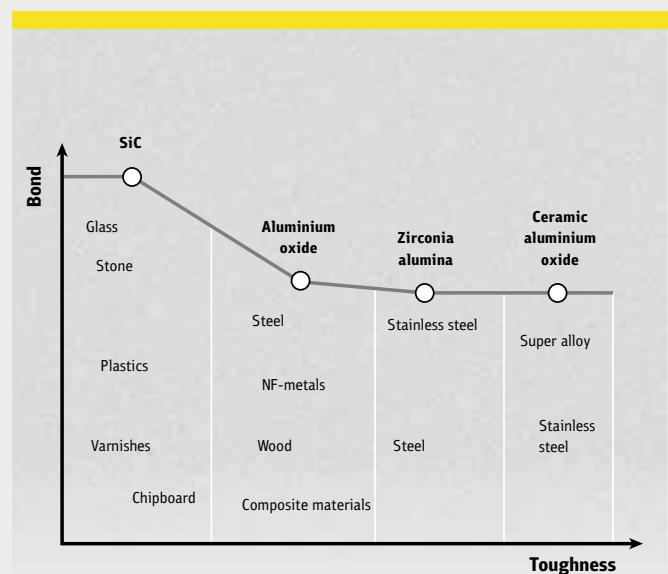

Grit classification in relation to bond, toughness and their primary applications

Coated abrasives

Applications guide

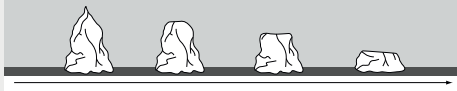
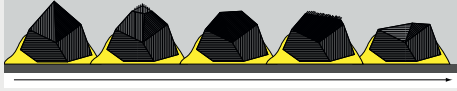
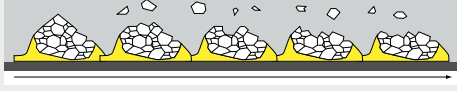
Grain type	Bond / toughness	Structure	Properties / wear properties
Silicon carbide (SiC)	very hard / less tough	crystalline	sharp-edged, brittle, highly friable / micro-wear 
Aluminium oxide	hard / tough	crystalline, irregular	wedge-shaped, block grain, even wear 
Zirconia alumina	hard / very tough	crystalline, even	wedge-shaped, blocky grit / micro-wear, self-sharpening 
Ceramic aluminium oxide	hard / very tough	micro-crystalline	sharp-edged, pointed grit / micro-wear, self-sharpening 

Grit type properties and their specific wear properties

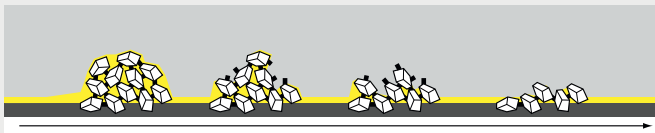

Definition	Description
close coating	The entire surface of the backing is coated with grit
semi-open coating	Approx. 75% of the backing surface is coated with grit
open coating	Approx. 50% of the backing surface is coated with grit

In addition, there are also so-called grit agglomerates. This is not an independent grit type, rather it is a grit agglomeration, which is comprised of many individual aluminium-oxide or SiC-grits mixed with a resin bonding agent, which together form a large grit. Agglomerates are used almost exclusively on abrasive belts.

The advantage of agglomerates is that they provide an even finish from the first use to the last. Dull grit breaks off from the agglomerate and creates space for new, sharp grit. The objective is to attain an even finish through continual stock removal and an extremely long service life.

Coating

Moreover, the coated abrasives are coated with different grit coverage densities. The term "grit density" describes the grit coverage density distributed on the backing.

One differentiates between:

- ▶ close coating
- ▶ semi-open coating
- ▶ open coating

Open coated grit has a large space between the individual grits, such that the stock removal and the grinding dust can be extracted more easily from the grinding surface. This prevents premature clogging when working on long-chipping materials, such as wood.

The decision as to which grit density to use is primarily dependent upon how great the likelihood is that the grinding dust will clog the space between the grits.

Grit size chart

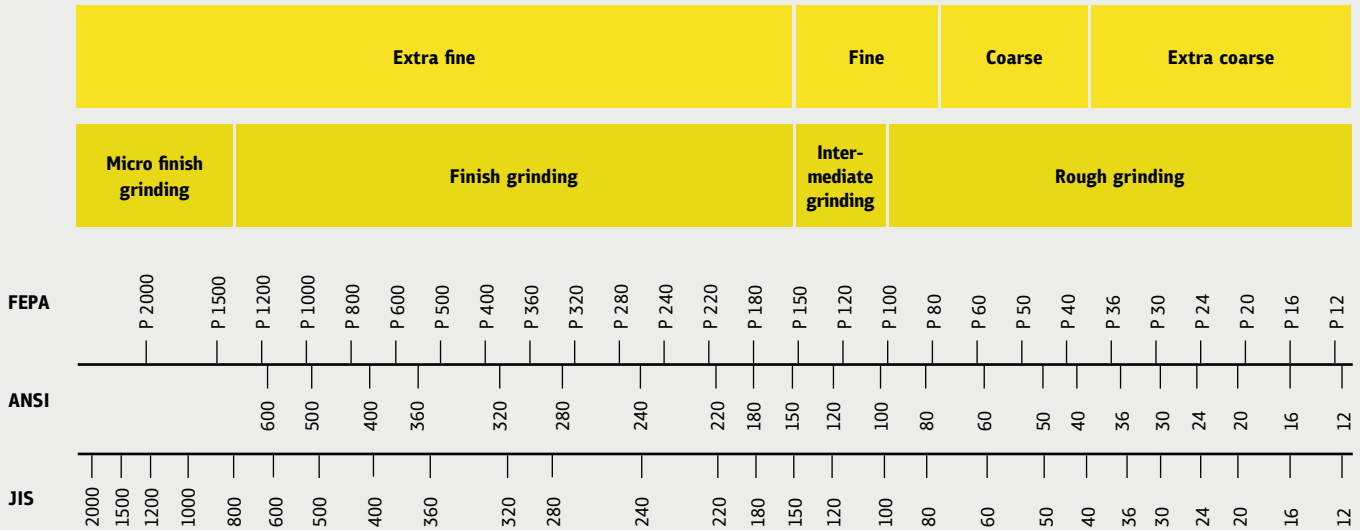

4. Size coat

The size coat supports the base coat in the anchoring of the grit on the backing and against forces which affect the grit during grinding. The cover bonds are produced exclusively from resin and also provide the product with its typical colour (exceptions are coated abrasives with additional coatings).

5. Special coatings

Special coatings with grinding aids provide the grinding tool properties that positively affect the grinding process and extends the service life of the coated abrasive. Special coatings are applied as an additional layer.

Stearate coating:

The stearate on a coated abrasive prevents the clogging and loading of the belt and is specifically suited for high quality varnish surface applications. Paints, varnishes and plastics can become soft and sticky through the heat generated from grinding, this can result in the premature clogging and loading of the belt. The dust clogs the space between the grits and this can result in additional "negative bond". This clogs the grits and the sharp edges are no longer effective. To prevent this from happening or to slow the process down, the coated abrasives can be coated with a non-stick material, so-called stearates.

Multibond:

The multibond, like the stearate coating, is applied in an additional production step to the cover bond layer. This allows the cool grinding of stainless steel and high alloy steels, which in turn increases the stock removal rate and service life.

ACT – Advanced Coating Technology:

Klingspor uses this technology to improve the properties of the coated abrasives. When working on metal, ACT provides significantly higher grit adhesion, e.g. for aggressive belt grinding of the edges of punched parts and castings. This significantly increases the life of the grinding belt. For belts that are used for wood and varnish grinding, ACT prevents the premature clogging of the coated abrasives and significantly increases the service life.

Antistatic:

Electrode migration is the result of friction i.e. grinding between different materials, and in turn causes charge separation, which in the case of non-conductive materials, such as wood, results in the load differences not being balanced. In these cases, the coated abrasive is equipped with anti-static properties that ground the electrical charge through the coated abrasive and the machine. This prevents the grinding dust from adhering to the workpiece, belt and machine.

Rolls with paper backing

Coated abrasives

Abrasive paper

PS 30 D



Properties

Bonding agent	Resin
Grain	Aluminium oxide
Coating	Semi-open
Backing	D-paper

Applications:

Paint/Varnish/Filler	●
Wood	●
Metals	○

Advantages: Sharp grit and high aggressiveness for use on wood, varnish, fillers - Flexible and tear resistant, easy folding - Product with good price-performance ratio

Available grits:

16	24	30	36	40	50	60	80	100	120	150	180	220	240	280	320	360	400	500	600	800	1000	1200	1500	2000
Width x Length in mm		Grit	Packing unit/pcs.	Cat. number	Price/piece AUD	Discount group																		
100 x 50000		40	1	252415	110.47 AUD	1																		
100 x 50000		60	1	252419	90.06 AUD	1																		
100 x 50000		80	1	252420	80.39 AUD	1																		
100 x 50000		120	1	252422	74.41 AUD	1																		
100 x 50000		180	1	252424	74.41 AUD	1																		
115 x 50000		40	1	174086	127.00 AUD	1																		
115 x 50000		60	1	174088	103.51 AUD	1																		
115 x 50000		80	1	174089	92.52 AUD	1																		
115 x 50000		120	1	174091	85.56 AUD	1																		
115 x 50000		180	1	174093	85.56 AUD	1																		

Other grits and sizes available on request.

Rolls with paper backing

Coated abrasives



Rolls

Finishing paper

PL 31 B



Properties

Bonding agent	Glue
Grain	Aluminium oxide
Coating	Semi-open
Backing	B-paper

Applications:

Paint/Varnish/Filler	●
Wood	●
Metals	⦿

Advantages: Product with optimal price-performance ratio - Optimized wear properties for hand sanding and handheld machine sanding

Available grits:

16	24	30	36	40	50	60	80	100	120	150	180	220	240	280	320	360	400	500	600	800	1000	1200	1500	2000
Width x Length in mm	Grit	Packing unit/pcs.	Cat. number	Price/piece AUD	Discount group																			
95 x 50000	60	1	3281	90.06 AUD	1																			
95 x 50000	80	1	3282	80.32 AUD	1																			
95 x 50000	100	1	3191	74.20 AUD	1																			
95 x 50000	120	1	3192	74.20 AUD	1																			

Abrasive paper

PS 33 C



Properties

Bonding agent	Resin
Grain	Aluminium oxide
Coating	Semi-open
Backing	C-paper

Applications:

Paint/Varnish/Filler	●
Wood	●
Plastic	⦿

Advantages: Very high removal rate - Minimal clogging due to active abrasive substances - Longer service life - Good tear resistance and flexibility

Available grits:

16	24	30	36	40	50	60	80	100	120	150	180	220	240	280	320	360	400	500	600	800	1000	1200	1500	2000
Width x Length in mm	Grit	Packing unit/pcs.	Cat. number	Price/piece AUD	Discount group																			
100 x 50000	80	1	248544	116.34 AUD	1																			
100 x 50000	100	1	201722	106.82 AUD	1																			
100 x 50000	120	1	300082	106.82 AUD	1																			
115 x 50000	40	1	158947	188.88 AUD	1																			
115 x 50000	60	1	155815	151.48 AUD	1																			
115 x 50000	80	1	147575	133.83 AUD	1																			
115 x 50000	100	1	147576	122.78 AUD	1																			
115 x 50000	120	1	153398	122.78 AUD	1																			

Other grits and sizes available on request.

Rolls with paper backing

Coated abrasives

Abrasive paper

PS 33 B



Properties

Bonding agent	Resin
Grain	Aluminium oxide
Coating	Semi-open
Backing	B-paper

Applications:

Paint/Varnish/Filler	●
Wood	●
Plastic	○

Advantages: Very high removal rate - Minimal clogging due to active abrasive substances - Longer service life - Good tear resistance and flexibility

Available grits:

16	24	30	36	40	50	60	80	100	120	150	180	220	240	280	320	360	400	500	600	800	1000	1200	1500	2000
Width x Length in mm		Grit	Packing unit/pcs.	Cat. number	Price/piece AUD	Discount group																		
100 x 50000		180	1	212055	106.82 AUD	1																		
100 x 50000		240	1	160282	107.72 AUD	1																		
115 x 50000		150	1	153177	122.78 AUD	1																		
115 x 50000		180	1	149480	122.78 AUD	1																		
115 x 50000		240	1	147055	123.92 AUD	1																		
115 x 50000		320	1	148891	123.92 AUD	1																		
115 x 50000		400	1	145520	123.92 AUD	1																		

Abrasive paper with foam backing

PS 73 CWF



Properties

Bonding agent	Resin
Grain	Aluminium oxide
Coating	Semi-open
Backing	C-paper + foam core

Applications:

Wood	●
Paint/Varnish/Filler	●
Plastic	●

Advantages: Very good distribution of sanding pressure due to elastic and conforming foam backing, therefore preventing over sanding of thin coatings and providing a very fine finish - High flexibility and very good adaptability to contours and profiles - Reduced clogging due to additional stearate coating and semi-open coated grain - Easy handling by tearing handy pads from a pre-perforated roll out of a dispenser box - Dimensions of abrasive pads: 115 x 140 mm, approx. 180 pcs

Available grits:

16	24	30	36	40	50	60	80	100	120	150	180	220	240	280	320	360	400	500	600	800	1000	1200	1500	2000
Width x Length in mm		Grit	Packing unit/pcs.	Cat. number	Price/piece AUD	Discount group																		
115 x 25000		120	1	321755	111.24 AUD	1																		

Other grits and sizes available on request.

Rolls with paper / cloth backing

Coated abrasives



Rolls

Abrasive paper with foam backing

PS 73 BWF



Properties

Bonding agent	Resin
Grain	Aluminium oxide
Coating	Semi-open
Backing	B-paper + foam core

Applications:

Wood	●
Paint/Varnish/Filler	●
Plastic	●

Advantages: Very good distribution of sanding pressure due to elastic and conforming foam backing, therefore preventing over sanding of thin coatings and providing a very fine finish - High flexibility and very good adaptability to contours and profiles - Reduced clogging due to additional stearate coating and semi-open coated grain - Easy handling by tearing handy pads from a pre-perforated roll out of a dispenser box - Dimensions of abrasive pads: 115 x 140 mm, approx. 180 pcs

Available grits:

16	24	30	36	40	50	60	80	100	120	150	180	220	240	280	320	360	400	500	600	800	1000	1200	1500	2000
----	----	----	----	----	----	----	----	-----	-----	-----	-----	-----	-----	-----	-----	-----	-----	-----	-----	-----	------	------	------	------

Width x Length in mm	Grit	Packing unit/pcs.	Cat. number	Price/piece AUD	Discount group
115 x 25000	180	1	321756	111.24 AUD	1
115 x 25000	240	1	321757	111.24 AUD	1
115 x 25000	320	1	321758	111.24 AUD	1
115 x 25000	400	1	321760	111.24 AUD	1
115 x 25000	600	1	325022	111.24 AUD	1

Abrasive cloth

KL 381 J



Properties

Bonding agent	Glue/resin
Grain	Aluminium oxide
Coating	Close
Backing	J-cotton

Applications:

Wood	●
Metals	●

Advantages: Standard product for wood and metal processing

Available grits:

16	24	30	36	40	50	60	80	100	120	150	180	220	240	280	320	360	400	500	600	800	1000	1200	1500	2000
----	----	----	----	----	----	----	----	-----	-----	-----	-----	-----	-----	-----	-----	-----	-----	-----	-----	-----	------	------	------	------

Width x Length in mm	Grit	Packing unit/pcs.	Cat. number	Price/piece AUD	Discount group
25 x 50000	40	1	313396	39.91 AUD	2
25 x 50000	60	1	337959	35.26 AUD	2
25 x 50000	80	1	337951	33.06 AUD	2
25 x 50000	120	1	337952	31.67 AUD	2
25 x 50000	180	1	313400	31.67 AUD	2
25 x 50000	240	1	337954	31.95 AUD	2
50 x 50000	40	1	337955	75.95 AUD	2
50 x 50000	60	1	337958	66.64 AUD	2
50 x 50000	80	1	337960	62.27 AUD	2

Other grits and sizes available on request.

Continuation →

Rolls with cloth backing

Coated abrasives

→ Continuation of KL 381 J, Abrasive cloth

Width x Length in mm	Grit	Packing unit/pcs.	Cat. number	Price/piece AUD	Discount group
50 x 50000	100	1	337957	59.51 AUD	2
50 x 50000	120	1	337956	59.51 AUD	2
50 x 50000	180	1	337961	59.51 AUD	2
50 x 50000	240	1	337962	60.07 AUD	2

Graphite coated canvas

CS 395 X



Properties

Grain	Graphite
Coating	Lamellar
Backing	X-cloth
Thickness	1,5 mm

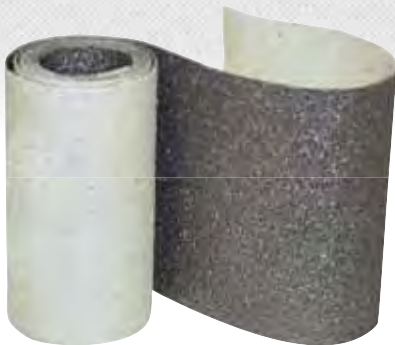

Advantages: Reduces friction between the back side of the belt and the contact element - Reduces heat generation during the grinding process - Enables a smooth and constant grinding

No self-fastening support

All sizes and minimum purchasing quantities available on request

Other grits and sizes available on request.

Non-woven web rolls

Coated abrasives



Rolls

Non-woven web roll

NRO 400



Properties

Bonding agent	Resin
Grain	Aluminium oxide

Applications:

Stainless steel	●	Paint/Varnish/Filler	⦿
Metals	●		
Wood	●		
Plastic	⦿		

Advantages: Very good adaptation to surface contours - No clogging - Ideal for smoothing, cleaning, roughening and for general surface finishing - Can be used wet and dry

Width x Length in mm	Colour	Grade	Packing unit/pcs.	Cat. number	Price/piece AUD	Discount group
115 x 10000	maroon	medium	1	258885	120.18 AUD	1
115 x 10000	dark green	very fine	1	258886	95.79 AUD	1
115 x 10000	maroon	very fine	1	258888	112.21 AUD	1
115 x 10000	white	without grain	1	299010	114.40 AUD	1

Non-woven web roll

NRO 500



Properties

Bonding agent	Resin
Grain	SiC

Applications:

Stainless steel	●	Wood	⦿
Plastic	●		
Paint/Varnish/Filler	●		
Metals	⦿		

Advantages: Very good adaptation to surface contours - No clogging - Ideal for smoothing, cleaning, roughening and for general surface finishing - Can be used wet and dry

Width x Length in mm	Colour	Grade	Packing unit/pcs.	Cat. number	Price/piece AUD	Discount group
115 x 10000	black	medium	1	260366	120.18 AUD	1
115 x 10000	grey	ultra fine	1	258889	112.21 AUD	1

Other grades and sizes available on request.

File belts

Coated abrasives

Abrasive cloth, multibond

CS 409 Y



Properties

Bonding agent	Resin
Grain	Zirconia alumina
Coating	Close
Backing	Y-polyester

Applications:

Stainless steel	●
NF metals	◐

Advantages: Aggressive abrasive behaviour - Cool grinding and increased grinding performance on stainless steel and high-alloy steels due to additional multibond - Very long service life also when used for grinding of non-ferrous metals

Available grits:

16	24	30	36	40	50	60	80	100	120	150	180	220	240	280	320	360	400	500	600	800	1000	1200	1500	2000
Width x Length in mm	Grit	Belt joint	Packing unit/pcs.	Cat. number	Price/piece AUD	Discount group																		
10 x 330	60	F4G	50	255422	2.87 AUD	4																		
20 x 520	60	F4G	50	255432	3.93 AUD	4																		

Abrasive cloth

CS 411 X



Properties

Bonding agent	Resin
Grain	Zirconia alumina
Coating	Close
Backing	X-cotton

Applications:

Stainless steel	●
Steel	●
Metals	●

Advantages: High aggressiveness and abrasive performance in rough grinding of steel and stainless steel - Very versatile in all areas of metalworking

Available grits:

16	24	30	36	40	50	60	80	100	120	150	180	220	240	280	320	360	400	500	600	800	1000	1200	1500	2000
Width x Length in mm	Grit	Belt joint	Packing unit/pcs.	Cat. number	Price/piece AUD	Discount group																		
10 x 330	60	F4G	25	78849	2.81 AUD	4																		
12 x 330	60	F4G	25	255423	2.81 AUD	4																		

Other grits and sizes available on request.

File belts

Coated abrasives



Abrasive cloth, waterproof

CS 416 Y



Properties

Bonding agent	Resin
Grain	Zirconia alumina
Coating	Semi-open
Backing	Y-polyester

Applications:

Stainless steel	●
Plastic	●
Leather	●
NF metals	⦿

Advantages: Very high aggressiveness and abrasive performance - Long service life also when used on materials that cause clogging

Available grits:

16	24	30	36	40	50	60	80	100	120	150	180	220	240	280	320	360	400	500	600	800	1000	1200	1500	2000
Width x Length in mm		Grit	Belt joint	Packing unit/pcs.	Cat. number	Price/piece AUD	Discount group																	
10 x 330		40	F4G	50	318648	2.73 AUD	4																	
10 x 330		60	F4G	50	307971	2.66 AUD	4																	
10 x 330		80	F4G	50	307972	2.58 AUD	4																	
10 x 330		120	F4G	50	318651	2.58 AUD	4																	
20 x 520		40	F4G	50	318649	3.66 AUD	4																	
20 x 520		60	F4G	50	307973	3.43 AUD	4																	
20 x 520		80	F4G	50	307974	3.36 AUD	4																	
20 x 520		120	F4G	50	318650	3.29 AUD	4																	

Other grits and sizes available on request.

Short belts for hand held machines

Coated abrasives

Abrasive cloth

LS 309 XH

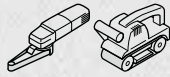

Properties

Bonding agent	Resin
Grain	Aluminium oxide
Coating	Close
Backing	X-cotton

Applications:

Wood	●
Metals	●
NF metals	●
Paint/Varnish/Filler	○

Advantages: Special type for portable belt sanders - For universal use on wood, metal, paint and varnish - Large product mix of belts for all standard machines

Available grits:

Width x Length in mm	Grit	Belt joint	Packing unit/pcs.	Cat. number	Price/piece AUD	Discount group
75 x 457	40	F5	10	329835	4.18 AUD	4
75 x 457	60	F5	10	329836	4.18 AUD	4
75 x 457	80	F5	10	329837	4.18 AUD	4
75 x 457	120	F5	10	329838	4.18 AUD	4
75 x 533	40	F5	10	321263	4.18 AUD	4
75 x 533	60	F5	10	321264	4.18 AUD	4
75 x 533	80	F5	10	321265	4.18 AUD	4
75 x 533	100	F5	10	321266	4.18 AUD	4
75 x 533	120	F5	10	321267	4.18 AUD	4
75 x 610	40	F5	10	321268	4.18 AUD	4
75 x 610	60	F5	10	321269	4.18 AUD	4
75 x 610	80	F5	10	321270	4.18 AUD	4
75 x 610	100	F5	10	321271	4.18 AUD	4
75 x 610	120	F5	10	321272	4.18 AUD	4
100 x 533	40	F5	10	329821	4.72 AUD	4
100 x 533	60	F5	10	329822	4.72 AUD	4
100 x 533	80	F5	10	329823	4.72 AUD	4
100 x 533	120	F5	10	329824	4.72 AUD	4
100 x 610	40	F5	10	321273	4.72 AUD	4
100 x 610	60	F5	10	321274	4.72 AUD	4
100 x 610	80	F5	10	321275	4.72 AUD	4
100 x 610	100	F5	10	321276	4.72 AUD	4
100 x 610	120	F5	10	321277	4.72 AUD	4

Other grits and sizes available on request.

Belts with paper backing

Coated abrasives



Abrasive paper

PS 21 F



Properties

Bonding agent	Resin
Grain	Zirconia alumin./ Al. oxide
Coating	Close
Backing	F-paper

Applications:

Stainless steel	●
Metals	●
Steel	●

Advantages: High aggressiveness and long service life due to self-sharpening zirconia alumina - Specially developed for rough grinding through finish grinding of stainless steel surfaces

Available grits:

16 24 30 36 40 50 60 80 100 120 150 180 220 240 280 320 360 400 500 600 800 1000 1200 1500 2000

All sizes and minimum purchasing quantities available on request

Abrasive paper, ANTISTATIC

PS 24 F ACT

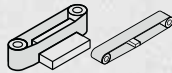

Properties

Bonding agent	Resin
Grain	SiC
Coating	Close
Backing	F-paper

Applications:

Paint/Varnish/Filler	●
Plastic	●
Wood	⓪

Advantages: For hard and tough surfaces - Finely sanded and varnish surfaces in the wood and furniture industry - Long service life due to ACT recipe and antistatic properties

Available grits:

16 24 30 36 40 50 60 80 100 120 150 180 220 240 280 320 360 400 500 600 800 1000 1200 1500 2000

All sizes and minimum purchasing quantities available on request

Abrasive paper, ANTISTATIC

PS 27 DW



Properties

Bonding agent	Resin
Grain	SiC
Coating	Open
Backing	D-paper

Applications:

Paint/Varnish/Filler	●
Aluminium	●
Plastic	⓪

Advantages: Special product for high-quality varnish surfaces, especially UV finishes - Substantially reduced clogging and longer service life due to additional special coating - Very fine surface scratch pattern

Available grits:

16 24 30 36 40 50 60 80 100 120 150 180 220 240 280 320 360 400 500 600 800 1000 1200 1500 2000

All sizes and minimum purchasing quantities available on request

Other grits and sizes available on request.

Belts with paper / cloth backing

Coated abrasives

Abrasive paper, ANTISTATIC

PS 29 F ACT

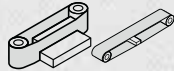

Properties	
Bonding agent	Resin
Grain	Aluminium oxide
Coating	Open
Backing	F-paper

Applications:	
Wood	●

Advantages: High-quality universal belt for general woodworking, especially softwood - Reduced clogging and longer service life due to ACT recipe and antistatic properties

Available grits:

16 24 30 36 40 50 60 80 100 120 150 180 220 240 280 320 360 400 500 600 800 1000 1200 1500 2000

All sizes and minimum purchasing quantities available on request

Abrasive film, active coated

FP 73 W



Properties	
Bonding agent	Resin
Grain	Aluminium oxide
Coating	Semi-open
Backing	Film

Applications:	
Paint/Varnish/Filler	●
Plastic	●

Advantages: Special product for processing varnish, plastic and composites - Highly tear-resistant film backing - Abrasive belt with extremely good adaptation, smooth surface and excellent grit adhesion - Substantially reduced clogging and significantly longer service life

Available grits:

16 24 30 36 40 50 60 80 100 120 150 180 220 240 280 320 360 400 500 600 800 1000 1200 1500 2000

All sizes and minimum purchasing quantities available on request

Abrasive cloth

LS 309 JF

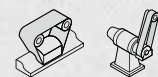

Properties	
Bonding agent	Resin
Grain	Aluminium oxide
Coating	Close
Backing	JF-cotton

Applications:	
Metals	●
NF metals	●
Wood	●

Advantages: High removal rate in metalworking and woodworking - Very good adaptation to radiuses and contours due to highly flexible cotton backing

Available grits:

16 24 30 36 40 50 60 80 100 120 150 180 220 240 280 320 360 400 500 600 800 1000 1200 1500 2000

All sizes and minimum purchasing quantities available on request

Other grits and sizes available on request.

Belts with cloth backing

Coated abrasives



Abrasive cloth

CS 310 X

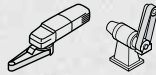

Properties

Bonding agent	Resin
Grain	Aluminium oxide
Coating	Close
Backing	X-cotton

Applications:

Stainless steel	●	Plastic	ⓘ
Wood	●		
Steel	●		
NF metals	●		

Advantages: High-quality universal type for metalworking and woodworking - Good removal rate under high stress

Available grits:

16	24	30	36	40	50	60	80	100	120	150	180	220	240	280	320	360	400	500	600	800	1000	1200	1500	2000
Width x Length in mm	Grit	Belt joint	Packing unit/pcs.	Cat. number	Price/piece AUD	Discount group																		
50 x 915	40	F4G	12	257198	8.64 AUD	4																		
50 x 915	60	F4G	12	257199	7.91 AUD	4																		
50 x 915	80	F4G	12	280156	7.56 AUD	4																		
50 x 915	120	F4G	12	284570	7.35 AUD	4																		

Abrasive cloth ANTISTATIC

CS 311 Y ACT

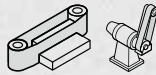

Properties

Bonding agent	Resin
Grain	Aluminium oxide
Coating	Open
Backing	Y-polyester

Applications:

Wood	●
Metals	ⓘ

Advantages: Good removal rate for working on wood under high stress - Minimal clogging and long service life due to ACT recipe and antistatic properties

Available grits:

16	24	30	36	40	50	60	80	100	120	150	180	220	240	280	320	360	400	500	600	800	1000	1200	1500	2000
----	----	----	----	----	----	----	----	-----	-----	-----	-----	-----	-----	-----	-----	-----	-----	-----	-----	-----	------	------	------	------

All sizes and minimum purchasing quantities available on request

Other grits and sizes available on request.

Belts with cloth backing

Coated abrasives

Abrasive cloth

LS 312 JF

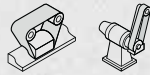

Properties

Bonding agent	Resin
Grain	Aluminium oxide
Coating	Close
Backing	JF-cotton

Applications:

Stainless steel	●	Wood	ⓘ
Metals	●		
NF metals	●		
Steel	●		

Advantages: Outstanding removal rate and service life due to active abrasive substances - Very good adaptation to radiuses and contours due to highly flexible cotton backing

Available grits:

16 24 30 36 40 50 60 80 100 120 150 180 220 240 280 320 360 400 500 600 800 1000 1200 1500 2000

All sizes and minimum purchasing quantities available on request

Abrasive cloth, waterproof

CS 320 Y



Properties

Bonding agent	Resin
Grain	SiC
Coating	Close
Backing	Y-polyester

Applications:

Glass/Stone	●
Mineral based materials	●
Plastic	●

Advantages: Outstanding abrasive performance on hard and difficult-to-machine materials - Ideal for high stress - Can be used wet or dry

Available grits:

16 24 30 36 40 50 60 80 100 120 150 180 220 240 280 320 360 400 500 600 800 1000 1200 1500 2000

All sizes and minimum purchasing quantities available on request

Abrasive cloth, waterproof

CS 321 X

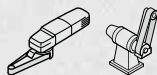

Properties

Bonding agent	Resin
Grain	SiC
Coating	Close
Backing	X-cotton

Applications:

Glass/Stone	●
Mineral based materials	●
Plastic	●

Advantages: Outstanding abrasive performance on hard and difficult-to-machine materials - Ideal for wet grinding, but also suitable for dry grinding

Available grits:

16 24 30 36 40 50 60 80 100 120 150 180 220 240 280 320 360 400 500 600 800 1000 1200 1500 2000

All sizes and minimum purchasing quantities available on request

Other grits and sizes available on request.

Belts with cloth backing

Coated abrasives



Belts

Abrasive cloth, waterproof

CS 322 X



Properties

Bonding agent	Resin
Grain	Cork
Backing	X-cotton

Applications:

Glass/Stone	●
-------------	---

Advantages: Special product for polishing glass with high quality cork/resin coating - Long life with consistent polishing effect - Waterproof

All sizes and minimum purchasing quantities available on request

Abrasive cloth, KULEX

CS 326 Y

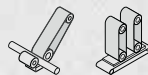

Properties

Bonding agent	Resin
Grain	Al. oxide agglom.
Backing	Y-polyester

Applications:

Stainless steel	●
Steel	●

Advantages: Long-life abrasive belt for a satin surface scratch pattern, under medium to high grinding pressure - Extremely long life, with consistent surface roughness and finish - Suitable for dry grinding

Available grits:

16 24 30 36 40 50 60 80 100 120 150 180 220 240 280 320 360 400 500 600 800 1000 1200 1500 2000

All sizes and minimum purchasing quantities available on request

Abrasive cloth, waterproof

CS 330 X



Properties

Bonding agent	Resin
Grain	SiC/Cork
Coating	Close
Backing	X-cotton

Applications:

Stainless steel	●
Steel	●

Advantages: Soft, very fine grinding with low surface roughness, polishable - Special belt for satin final finishing of stainless steel and steel surfaces with cork granulate with SiC/resin coating

Available grits:

16 24 30 36 40 50 60 80 100 120 150 180 220 240 280 320 360 400 500 600 800 1000 1200 1500 2000

All sizes and minimum purchasing quantities available on request

Other grits and sizes available on request.

Belts with cloth backing

Coated abrasives

Abrasive cloth, multibond

CS 409 Y



Properties

Bonding agent	Resin
Grain	Zirconia alumina
Coating	Close
Backing	Y-polyester

Applications:

Stainless steel	●
NF metals	◐

Advantages: Aggressive abrasive behaviour - Cool grinding and increased grinding performance on stainless steel and high-alloy steels due to additional multibond - Very long service life also when used for grinding of non-ferrous metals

Available grits:

16	24	30	36	40	50	60	80	100	120	150	180	220	240	280	320	360	400	500	600	800	1000	1200	1500	2000
Width x Length in mm	Grit	Belt joint	Packing unit/pcs.	Cat. number	Price/piece AUD	Discount group																		
50 x 915	40	F4G	12	280201	12.18 AUD	4																		
50 x 915	60	F4G	12	280202	11.04 AUD	4																		
50 x 915	80	F4G	12	280203	10.44 AUD	4																		
50 x 915	120	F4G	12	280204	10.12 AUD	4																		

Abrasive cloth

CS 411 X

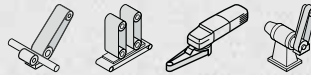

Properties

Bonding agent	Resin
Grain	Zirconia alumina
Coating	Close
Backing	X-cotton

Applications:

Stainless steel	●
Steel	●
Metals	●

Advantages: High aggressiveness and abrasive performance in rough grinding of steel and stainless steel - Very versatile in all areas of metalworking

Available grits:

16	24	30	36	40	50	60	80	100	120	150	180	220	240	280	320	360	400	500	600	800	1000	1200	1500	2000
----	----	----	----	----	----	----	----	-----	-----	-----	-----	-----	-----	-----	-----	-----	-----	-----	-----	-----	------	------	------	------

All sizes and minimum purchasing quantities available on request

Other grits and sizes available on request.

Belts with cloth backing

Coated abrasives



Abrasive cloth, waterproof

CS 412 Y

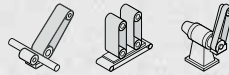

Properties

Bonding agent	Resin
Grain	Aluminium oxide
Coating	Close
Backing	Y-polyester

Applications:

Metals	●	Wood	●
NF metals	●		
Stainless steel	●		
Steel	●		

Advantages: High-quality universal type for wet and dry grinding of stainless steel, steel and other metal surfaces

Available grits:

16 24 30 36 40 50 60 80 100 120 150 180 220 240 280 320 360 400 500 600 800 1000 1200 1500 2000

All sizes and minimum purchasing quantities available on request

Abrasive cloth, waterproof

CS 416 Y

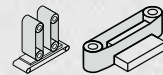

Properties

Bonding agent	Resin
Grain	Zirconia alumina
Coating	Semi-open
Backing	Y-polyester

Applications:

Stainless steel	●
Plastic	●
NF metals	●

Advantages: Very high aggressiveness and abrasive performance - Long service life also when used on materials that cause clogging

Available grits:

16 24 30 36 40 50 60 80 100 120 150 180 220 240 280 320 360 400 500 600 800 1000 1200 1500 2000

Width x Length in mm	Grit	Belt joint	Packing unit/pcs.	Cat. number	Price/piece AUD	Discount group
50 x 915	40	F4G	12	280622	10.04 AUD	4
50 x 915	60	F4G	12	280623	9.12 AUD	4
50 x 915	80	F4G	12	280624	8.67 AUD	4
50 x 915	120	F4G	12	280665	8.39 AUD	4
50 x 1220	40	F4G	12	281992	12.62 AUD	4
50 x 1220	60	F4G	12	281993	11.40 AUD	4
50 x 1220	80	F4G	12	281994	10.83 AUD	4
50 x 1220	120	F4G	12	282065	10.48 AUD	4
75 x 2000	36	F4G	10	204858	30.27 AUD	4
75 x 2000	40	F4G	10	205377	27.26 AUD	4
75 x 2000	60	F4G	10	207651	24.23 AUD	4
100 x 915	40	F4G	12	284572	17.51 AUD	4
100 x 915	60	F4G	12	284573	15.70 AUD	4
100 x 915	80	F4G	12	284575	14.78 AUD	4
100 x 915	120	F4G	12	318652	14.27 AUD	4
150 x 2000	36	F4G	10	231336	56.52 AUD	4
150 x 2000	40	F4G	10	205474	50.48 AUD	4
150 x 2000	60	F4G	10	204213	44.46 AUD	4

Other grits and sizes available on request.

Belts with cloth backing / Non-woven web belts

Coated abrasives

Abrasive cloth, waterproof

CS 912 Y ACT

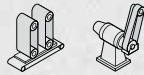

Properties

Bonding agent	Resin
Grain	Ceramic Al. oxide
Coating	Close
Backing	Y-polyester

Applications:

Stainless steel	●
Steel	●

Advantages: Continuously aggressive abrasive performance, with long service life due to ceramic grit - High-performance abrasive belt for stainless steel finish grinding

Available grits:

16 24 30 36 40 50 60 80 100 120 150 180 220 240 280 320 360 400 500 600 800 1000 1200 1500 2000

All sizes and minimum purchasing quantities available on request

Non-woven web belt

NBS 800

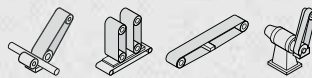

Properties

Bonding agent	Resin
Grain	Aluminium oxide

Applications:

Stainless steel	●
NF metals	●
Metals	●

Advantages: Special product for surface finishing with hand-operated machines (except hand tool belt grinders) and stationary machines - Ideal for removal of discolorations, for light deburring, leveling, matte finishing and roughening - Minimal clogging - Long service life - Suitable for dry and wet grinding

All sizes and minimum purchasing quantities available on request

Other grits and sizes available on request.

Abrasive sleeves / Rubber drums

Coated abrasives



Abrasive cloth, multibond

CS 410 X

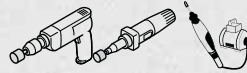

Properties

Bonding agent	Resin
Grain	Aluminium oxide
Coating	Close
Backing	X-cotton

Applications:

Stainless steel	●
NF metals	⓪

Advantages: Tear-resistant cloth with reinforced backing - Spiral shaped joint, cylindrical form - Cool grinding and no heat tinting due to additional multibond - Increased abrasive performance for use on stainless steel - High aggressiveness when used with rubber drum GK 555

Available grits:

16	24	30	36	40	50	60	80	100	120	150	180	220	240	280	320	360	400	500	600	800	1000	1200	1500	2000
----	----	----	----	----	----	----	----	-----	-----	-----	-----	-----	-----	-----	-----	-----	-----	-----	-----	-----	------	------	------	------

Diameter x Height in mm	Grit	Packing unit/pcs.	Cat. number	Price/piece AUD	Discount group
19 x 25	40	50	324115	2.79 AUD	4
19 x 25	60	50	324116	2.79 AUD	4
19 x 25	80	50	328370	2.79 AUD	4
19 x 25	120	50	328369	2.79 AUD	4
25 x 25	40	50	324117	3.09 AUD	4
25 x 25	60	50	324118	3.09 AUD	4
25 x 25	80	50	328368	3.09 AUD	4
25 x 25	120	50	328367	3.09 AUD	4
38 x 25	40	50	324119	3.95 AUD	4
38 x 25	60	50	324121	3.95 AUD	4
38 x 25	80	50	328366	3.95 AUD	4
38 x 25	120	50	328365	3.95 AUD	4

Rubber drums

GK 555



Advantages: Reusable rubber drum for cylindrical abrasive sleeves CS 310 X and CS 451 X - Mounting and dismounting by a light turn

Diameter x Width x Shaft in mm	Max. operating speed	Max. RPM	Packing unit/pcs.	Cat. number	Price/piece AUD	Discount group
19 x 25 x 6	30 m/s	30000 rpm	1	329898	32.70 AUD	14
25 x 25 x 6	30 m/s	23000 rpm	1	329897	37.56 AUD	14
38 x 25 x 6	30 m/s	15000 rpm	1	329899	37.56 AUD	14

Other grits and sizes available on request.

Wide belts with paper backing

Coated abrasives

Abrasive paper

PS 21 F



Properties

Bonding agent	Resin
Grain	Zirconia alumina
Coating	Close
Backing	F-paper

Applications:

Stainless steel	●
Metals	●
Steel	●

Advantages: Aggressive abrasive behaviour due to self-sharpening zirconia alumina - Optimal recipe for rough grinding and finish grinding of stainless steel

Available grits:

16 24 30 36 40 50 60 80 100 120 150 180 220 240 280 320 360 400 500 600 800 1000 1200 1500 2000

All sizes and minimum purchasing quantities available on request

Abrasive paper, ANTISTATIC

PS 22 F ACT



Properties

Bonding agent	Resin
Grain	Aluminium oxide
Coating	Close
Backing	F-paper

Applications:

Wood	●	Plastic	⦿
Metals	⦿		
NF metals	⦿		
Paint/Varnish/Filler	⦿		

Advantages: High removal rate, fine surface scratch pattern, especially suitable for hardwood, HPL panels and melamine and primer foil coatings - Reduced clogging and longer service life due to ACT recipe and antistatic properties

Available grits:

16 24 30 36 40 50 60 80 100 120 150 180 220 240 280 320 360 400 500 600 800 1000 1200 1500 2000

All sizes and minimum purchasing quantities available on request

Other sizes available on request.

Wide belts with paper backing

Coated abrasives



Abrasive paper, ANTISTATIC

PS 24 F ACT



Properties

Bonding agent	Resin
Grain	SiC
Coating	Close
Backing	F-paper

Applications:

Stainless steel	●
Paint/Varnish/Filler	●
Plastic	●
Wood	⓪

Advantages: For hard and tough surfaces - Produces a brilliant, high gloss finish on stainless steel surfaces due to the very hard and sharp-edged silicon carbide grit - Long service life on varnish surfaces in the wood and furniture industry due to ACT recipe and antistatic properties

Available grits:

- 16
- 24
- 30
- 36
- 40
- 50
- 60
- 80
- 100
- 120
- 150
- 180
- 220
- 240
- 280
- 320
- 360
- 400
- 500
- 600
- 800
- 1000
- 1200
- 1500
- 2000

All sizes and minimum purchasing quantities available on request

Abrasive paper, ANTISTATIC

PS 27 DW



Properties

Bonding agent	Resin
Grain	SiC
Coating	Open
Backing	D-paper

Applications:

Paint/Varnish/Filler	●
Aluminium	●
Plastic	⓪

Advantages: Special product for high-quality varnish surfaces, especially UV finishes - Substantially reduced clogging and significantly longer service life due to additional stearate coating and antistatic properties

Available grits:

- 16
- 24
- 30
- 36
- 40
- 50
- 60
- 80
- 100
- 120
- 150
- 180
- 220
- 240
- 280
- 320
- 360
- 400
- 500
- 600
- 800
- 1000
- 1200
- 1500
- 2000

All sizes and minimum purchasing quantities available on request

Other sizes available on request.

Wide belts with paper / cloth backing

Coated abrasives

Abrasive paper, ANTISTATIC

PS 29 F ACT



Properties

Bonding agent	Resin
Grain	Aluminium oxide
Coating	Open
Backing	F-paper

Applications:

Wood	●
------	---

Advantages: High-quality universal type for general woodworking - Large product mix - Reduced clogging and longer service life due to ACT recipe and antistatic properties

Available grits:

16 24 30 36 40 50 60 80 100 120 150 180 220 240 280 320 360 400 500 600 800 1000 1200 1500 2000

All sizes and minimum purchasing quantities available on request

Abrasive cloth

CS 310 X



Properties

Bonding agent	Resin
Grain	Aluminium oxide
Coating	Close
Backing	X-cotton

Applications:

Metals	●	Plastic	○
Steel	●		
Stainless steel	●		
Wood	○		

Advantages: Universal product with optimal price-performance ratio - Available in a wide grit range

Available grits:

16 24 30 36 40 50 60 80 100 120 150 180 220 240 280 320 360 400 500 600 800 1000 1200 1500 2000

All sizes and minimum purchasing quantities available on request

Other sizes available on request.

Wide belts with cloth backing

Coated abrasives



Abrasive cloth ANTISTATIC

CS 311 Y ACT



Properties

Bonding agent	Resin
Grain	Aluminium oxide
Coating	Open
Backing	Y-polyester

Applications:

Wood	●
Metals	⓪

Advantages: Specially developed for calibration grinding of wood - Reduced clogging and longer service life due to ACT recipe and antistatic properties

Available grits:

16 24 30 36 40 50 60 80 100 120 150 180 220 240 280 320 360 400 500 600 800 1000 1200 1500 2000

All sizes and minimum purchasing quantities available on request

Abrasive cloth, waterproof

CS 320 Y



Properties

Bonding agent	Resin
Grain	SiC
Coating	Close
Backing	Y-polyester

Applications:

Mineral based materials	●
Plastic	●

Advantages: Very hard and sharp silicon carbide grain for hard and tough workpiece surfaces - High aggressiveness and abrasive performance - Especially suitable for wet grinding

Available grits:

16 24 30 36 40 50 60 80 100 120 150 180 220 240 280 320 360 400 500 600 800 1000 1200 1500 2000

All sizes and minimum purchasing quantities available on request

Other sizes available on request.

Wide belts with cloth backing

Coated abrasives

Abrasive cloth, waterproof

CS 321 X



Properties

Bonding agent	Resin
Grain	SiC
Coating	Close
Backing	X-cotton

Applications:

Mineral based materials	●
Plastic	●
Stainless steel	●

Advantages: Produces a brilliant, glossy finish on stainless steel surfaces due to the very hard and sharp-edged silicon carbide grit - Very high aggressiveness and abrasive performance - Especially suitable for wet grinding

Available grits:

16 24 30 36 40 50 60 80 100 120 150 180 220 240 280 320 360 400 500 600 800 1000 1200 1500 2000

All sizes and minimum purchasing quantities available on request

Abrasive cloth, KULEX

CS 326 Y



Properties

Bonding agent	Resin
Grain	Al. oxide agglom.
Backing	Y-polyester

Applications:

Stainless steel	●
Steel	●

Advantages: Long-life abrasive belt for a satin surface scratch pattern, under medium to high grinding pressure - Extremely long life, with consistent surface roughness and finish - Suitable for dry grinding

Available grits:

16 24 30 36 40 50 60 80 100 120 150 180 220 240 280 320 360 400 500 600 800 1000 1200 1500 2000

All sizes and minimum purchasing quantities available on request

Other sizes available on request.

Wide belts with cloth backing

Coated abrasives



Abrasive cloth, multibond

CS 409 Y



Properties

Bonding agent	Resin
Grain	Zirconia alumina
Coating	Close
Backing	Y-polyester

Applications:

Stainless steel	●
-----------------	---

Advantages: Aggressive abrasive behaviour due to self-sharpening zirconia alumina - Prevents heat tinting on stainless steel - Cool grinding due to additional multibond - Minimal clogging when used on aluminium and aluminium alloys

Available grits:

16 24 30 36 40 50 60 80 100 120 150 180 220 240 280 320 360 400 500 600 800 1000 1200 1500 2000

All sizes and minimum purchasing quantities available on request

Abrasive cloth

CS 411 X



Properties

Bonding agent	Resin
Grain	Zirconia alumina
Coating	Close
Backing	X-cotton

Applications:

Steel	●
Stainless steel	●
Metals	●

Advantages: Aggressive abrasive behaviour - High-performance product for use on steel and stainless steel

Available grits:

16 24 30 36 40 50 60 80 100 120 150 180 220 240 280 320 360 400 500 600 800 1000 1200 1500 2000

All sizes and minimum purchasing quantities available on request

Other sizes available on request.

Wide belts with cloth backing

Coated abrasives

Abrasive cloth, waterproof

CS 412 Y



Properties

Bonding agent	Resin
Grain	Aluminium oxide
Coating	Close
Backing	Y-polyester

Applications:

Stainless steel	●	Wood	ⓘ
Metals	●		
Steel	●		
NF metals	●		

Advantages: Universal product for rough and intermediate grinding of steel and non-ferrous metals

Available grits:

16 24 30 36 40 50 60 80 100 120 150 180 220 240 280 320 360 400 500 600 800 1000 1200 1500 2000

All sizes and minimum purchasing quantities available on request

Abrasive cloth, waterproof

CS 416 Y



Properties

Bonding agent	Resin
Grain	Zirconia alumina
Coating	Semi-open
Backing	Y-polyester

Applications:

Stainless steel	●
Plastic	●
Leather	●
NF metals	ⓘ

Advantages: Very high aggressiveness and abrasive performance - Long service life also when used on materials that cause clogging

Available grits:

16 24 30 36 40 50 60 80 100 120 150 180 220 240 280 320 360 400 500 600 800 1000 1200 1500 2000

All sizes and minimum purchasing quantities available on request

Other sizes available on request.

Wide belts with cloth backing

Coated abrasives



Abrasive cloth

CS 912 Y ACT



Properties

Bonding agent	Resin
Grain	Ceramic Al. oxide
Coating	Close
Backing	Y-polyester

Applications:

Stainless steel	●
Steel	●

Advantages: Continuously aggressive abrasive behaviour due to micro-crystalline and self-sharpening ceramic grit - High performance abrasive belt for stainless steel finish grinding

Available grits:

16 24 30 36 40 50 60 80 100 120 150 180 220 240 280 320 360 400 500 600 800 1000 1200 1500 2000

All sizes and minimum purchasing quantities available on request

Other sizes available on request.





Fibre discs

About the product

Klingspor fibre discs have high material removal rates and service life, producing an optimal finish. Suitable backing plates complete the product range.

Areas of use are steel, stainless steel, non-ferrous metal and cast iron. The comprehensive grit range makes it possible to select the right tool for every application. Even the most difficult of surfaces can be worked on easily with the fibre discs.

Klingspor fibre discs are outstanding for rough grinding and sanding, de-rusting metal parts, deburring and grinding welded seams. These discs are also suitable for precision finishing work on metals.

The state-of-the-art laser cutting technology allows special shapes for specific applications.

Quality and performance

- ▶ Low clogging rate
- ▶ Market leading service life
- ▶ Even grinding finish
- ▶ Cool grinding



Applications Fibre Discs					
Application	Type	Grain	Backing	Coating	Characteristics
Steel, NF metals	CS 561	Aluminium oxide	Fibre	●	Abrasive fibre disc for working on steel and NF metals
Steel, stainless steel	FS 764 ACT	Aluminium oxide	Fibre	●	Abrasive fibre disc for processing steel and non-ferrous metals. High aggressiveness and long service life due to new Advanced Coating Technology
	CS 565	Zirconia alumina	Fibre	●	Abrasive fibre disc with high stock removal rate for rough grinding and deburring of steel and stainless steel
	FS 964 ACT	Ceramic aluminium oxide	Fibre	●	Premium fibre disc with microcrystalline, self-sharpening ceramic grit delivering superior aggressiveness and removal on construction steel and high-alloy steels. Outstanding grit adhesion and service life thanks to Advanced Coating Technology.
Stainless steel	CS 570	Zirconia alumina	Fibre	●	High performance fibre disc with additional multibond for high stock removal rate and long service life for cool grinding on stainless steel and high-alloy steel, especially for surface grinding
	FS 966 ACT	Ceramic aluminium oxide	Fibre	●	High performance fibre disc with very high stock removal rate and extremely long service life, with self-sharpening ceramic grain for the processing of high-alloy steel, multibond for cool grinding. Improved grit adhesion due to Advanced Coating Technology

● = close ● = semi-open ○ = open

Fibre discs

Applications guide





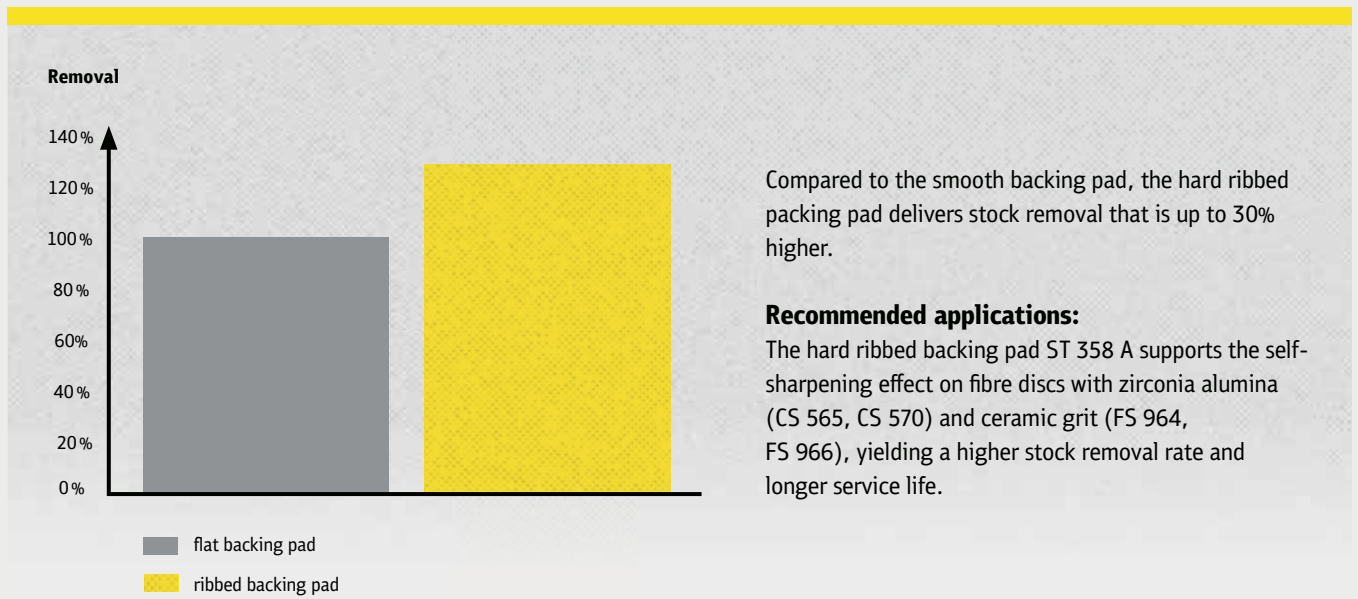



Technical information about the backing pad

The right backing pad		
Product	 ST 358	 ST 358 A
Backing pad form	Medium hard, flat	Hard, ribbed
Benefit	Even grinding finish, good adaptation to the workpiece	High material removal rates, high stability
		Additional benefit of our ribbed backing pad: increased aggression, cool grinding
Application	Finish grinding (grit 50 and finer), edge rounding, contour grinding, surface grinding	Rough grinding (up to grit 40 and rougher), chamfering, deburring work, welded seam work



The safe use of Klingspor abrasives

Klingspor fibre discs have been tested according to the guidelines of the oSa directives and are guaranteed to comply with European safety standard EN 12413

-  Wear safety goggles or glasses to protect the eyes
-  Wear safety gloves to protect hands
-  Wear a dust mask
-  Observe safety instructions
-  Use ear muffs
-  Do not use for wet grinding
-  Only permitted with a backing pad
-  Do not use if damaged

Fibre discs

Applications guide



Hole pattern for fibre discs



10 = round hole



30 = star shaped hole

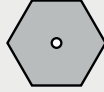

Additional special cutting shapes are available on request. Please ask us!



Minimum order quantities for made to order items

Disc diameter	Min. order quantities
up to 235 mm	1,000 pieces

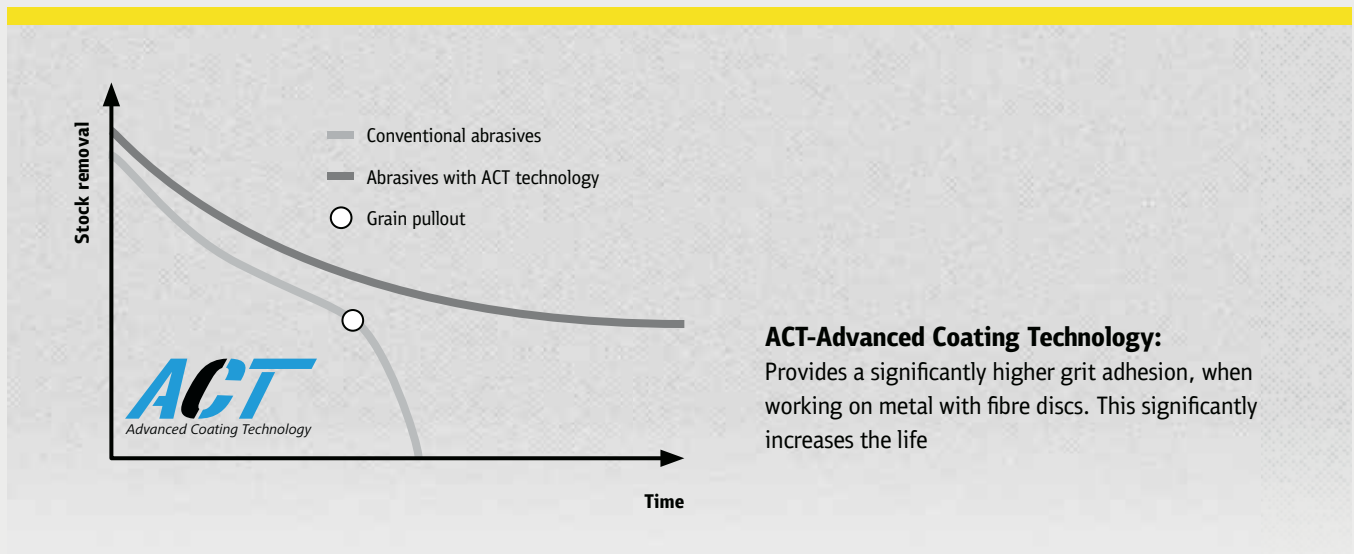

Fibre discs

Coated abrasives

Abrasive fibre disc

CS 561



Properties

Bonding agent	Resin
Grain	Aluminium oxide
Coating	Close

Applications:

Steel	●	Stainless steel	⓪
NF metals	●	Wood	⓪
Metals	●		
Plastic	⓪		

Advantages: For universal use - Largest selection of diameters, grit sizes and hole patterns

Available grits:

16 24 30 36 40 50 60 80 100 120 150 180 220 240 280 320 360 400 500 600 800 1000 1200 1500 2000																					
Diameter x Hole in mm	Grit	Hole pattern	Packing unit/pcs.	Cat. number	Price/100 pieces AUD	Discount group															
100 x 16	16	⊙ 10	25	65708	174.00 AUD	8															
100 x 16	24	⊙ 10	25	65713	141.40 AUD	8															
100 x 16	36	⊙ 10	25	65718	131.70 AUD	8															
100 x 16	60	⊙ 10	25	65730	101.10 AUD	8															
100 x 16	80	⊙ 10	25	65735	98.10 AUD	8															
100 x 16	100	⊙ 10	25	65739	98.10 AUD	8															
100 x 16	120	⊙ 10	25	65743	98.10 AUD	8															
115 x 22	24	⊗ 30	25	10978	166.00 AUD	8															
115 x 22	36	⊗ 30	25	10980	154.50 AUD	8															
115 x 22	60	⊗ 30	25	10983	118.90 AUD	8															
115 x 22	80	⊗ 30	25	10984	115.20 AUD	8															
115 x 22	120	⊗ 30	25	10986	115.20 AUD	8															
125 x 22	16	⊗ 30	25	11009	239.00 AUD	8															
125 x 22	24	⊗ 30	25	11010	195.00 AUD	8															
125 x 22	36	⊗ 30	25	11012	181.00 AUD	8															
125 x 22	50	⊗ 30	25	11014	152.60 AUD	8															
125 x 22	60	⊗ 30	25	11015	139.10 AUD	8															
125 x 22	80	⊗ 30	25	11016	135.10 AUD	8															
125 x 22	120	⊗ 30	25	11018	135.10 AUD	8															
180 x 22	24	⊙ 10	25	66451	354.00 AUD	8															
180 x 22	36	⊙ 10	25	66459	329.00 AUD	8															
180 x 22	16	⊗ 30	25	11057	437.00 AUD	8															
180 x 22	24	⊗ 30	25	11058	354.00 AUD	8															
180 x 22	36	⊗ 30	25	11060	329.00 AUD	8															
180 x 22	60	⊗ 30	25	11063	253.00 AUD	8															
180 x 22	80	⊗ 30	25	11064	246.00 AUD	8															
180 x 22	100	⊗ 30	25	11065	246.00 AUD	8															
180 x 22	120	⊗ 30	25	11066	246.00 AUD	8															

Backing pads see page 46-47 / Dispenser see page 47

Abrasive fibre disc

CS 565



Properties

Bonding agent	Resin
Grain	Zirconia alumina
Coating	Close

Applications:

Stainless steel	●
Steel	●
Metals	●

Advantages: Self-sharpening effect - High aggressiveness on steel and stainless steel - Ideal for rough grinding work - Excellent price-performance ratio

Available grits:

16	24	30	36	40	50	60	80	100	120	150	180	220	240	280	320	360	400	500	600	800	1000	1200	1500	2000
----	----	----	----	----	----	----	----	-----	-----	-----	-----	-----	-----	-----	-----	-----	-----	-----	-----	-----	------	------	------	------

Diameter x Hole in mm	Grit	Hole pattern	Packing unit/pcs.	Cat. number	Price/100 pieces AUD	Discount group
100 x 16	24	⊙ 10	25	100711	188.00 AUD	8
100 x 16	36	⊙ 10	25	23680	174.00 AUD	8
100 x 16	60	⊙ 10	25	84604	138.10 AUD	8
100 x 16	80	⊙ 10	25	188678	134.00 AUD	8
115 x 22	24	⊗ 30	25	95335	219.00 AUD	8
115 x 22	36	⊗ 30	25	6686	205.00 AUD	8
115 x 22	40	⊗ 30	25	242801	188.00 AUD	8
115 x 22	60	⊗ 30	25	6687	162.00 AUD	8
115 x 22	80	⊗ 30	25	6688	157.50 AUD	8
125 x 22	24	⊗ 30	25	97643	258.00 AUD	8
125 x 22	36	⊗ 30	25	6620	239.00 AUD	8
125 x 22	50	⊗ 30	25	93054	209.00 AUD	8
125 x 22	60	⊗ 30	25	6721	189.00 AUD	8
125 x 22	80	⊗ 30	25	23005	184.00 AUD	8
180 x 22	24	⊗ 30	25	95993	467.00 AUD	8
180 x 22	36	⊗ 30	25	65703	434.00 AUD	8
180 x 22	60	⊗ 30	25	6690	345.00 AUD	8
180 x 22	80	⊗ 30	25	6691	335.00 AUD	8

Fibre discs

Coated abrasives

Abrasive fibre disc, multibond

CS 570



Properties

Bonding agent	Resin
Grain	Zirconia alumina
Coating	Close

Applications:

Stainless steel	●
Aluminium	●
NF metals	◐

Advantages: Self-sharpening effect - High aggressiveness, especially suitable for stainless steel - Increase in performance due to low temperatures - Multibond prevents heat tinting - Especially suitable for use on aluminium

Available grits:

16 24 30 36 40 50 60 80 100 120 150 180 220 240 280 320 360 400 500 600 800 1000 1200 1500 2000																					
Diameter x Hole in mm	Grit	Hole pattern	Packing unit/pcs.	Cat. number	Price/100 pieces AUD	Discount group															
100 x 16	36	⊙ 10	25	204823	188.00 AUD	8															
100 x 16	60	⊙ 10	25	204825	143.60 AUD	8															
100 x 16	80	⊙ 10	25	204826	139.50 AUD	8															
100 x 16	120	⊙ 10	25	204828	139.50 AUD	8															
115 x 22	36	⊛ 30	25	204086	219.00 AUD	8															
115 x 22	60	⊛ 30	25	204088	169.00 AUD	8															
115 x 22	80	⊛ 30	25	204089	163.90 AUD	8															
115 x 22	120	⊛ 30	25	204091	163.90 AUD	8															
125 x 22	24	⊛ 30	25	204092	274.00 AUD	8															
125 x 22	36	⊛ 30	25	204093	257.00 AUD	8															
125 x 22	60	⊛ 30	25	204095	198.00 AUD	8															
125 x 22	80	⊛ 30	25	204096	191.00 AUD	8															
125 x 22	100	⊛ 30	25	204097	191.00 AUD	8															
125 x 22	120	⊛ 30	25	204098	191.00 AUD	8															
180 x 22	24	⊛ 30	25	204099	497.00 AUD	8															
180 x 22	36	⊛ 30	25	204100	467.00 AUD	8															
180 x 22	60	⊛ 30	25	204102	359.00 AUD	8															
180 x 22	80	⊛ 30	25	204103	349.00 AUD	8															
180 x 22	120	⊛ 30	25	204105	349.00 AUD	8															

Backing pads see page 46-47 / Dispenser see page 47

Abrasive fibre disc

FS 964 ACT



Properties

Bonding agent	Resin
Grain	Ceramic Al. oxide
Coating	Close

Applications:

Steel	●
Stainless steel	●

Advantages: Premium product with excellent performance for working on steel - Micro-crystalline self-sharpening effect - High aggressiveness thanks to self-sharpening, aggressive ceramic grains throughout the service life - Outstanding grit adhesion - Advanced coating technology (ACT) for extraordinary grain adhesion and extended service life

Available grits:

16	24	30	36	40	50	60	80	100	120	150	180	220	240	280	320	360	400	500	600	800	1000	1200	1500	2000
Diameter x Hole in mm	Grit	Hole pattern	Packing unit/pcs.	Cat. number	Price/100 pieces AUD	Discount group																		
125 x 22	24	⊗ 30	25	330484	391.00 AUD	8																		
125 x 22	36	⊗ 30	25	330485	343.00 AUD	8																		
125 x 22	60	⊗ 30	25	330487	269.00 AUD	8																		
125 x 22	80	⊗ 30	25	330490	250.00 AUD	8																		
125 x 22	120	⊗ 30	25	330491	250.00 AUD	8																		
180 x 22	24	⊗ 30	25	330489	712.00 AUD	8																		
180 x 22	36	⊗ 30	25	330492	627.00 AUD	8																		
180 x 22	60	⊗ 30	25	330495	489.00 AUD	8																		

Abrasive fibre disc, multibond

FS 966 ACT



Properties

Bonding agent	Resin
Grain	Ceramic Al. oxide
Coating	Close

Applications:

Stainless steel	●
-----------------	---

Advantages: Micro-crystalline self-sharpening effect - High aggressiveness throughout the service life - Outstanding grit adhesion - Long service life, especially suitable for heavy duty applications - Increase in performance due to low temperatures - Multibond prevents heat tinting

Available grits:

16	24	30	36	40	50	60	80	100	120	150	180	220	240	280	320	360	400	500	600	800	1000	1200	1500	2000
Diameter x Hole in mm	Grit	Hole pattern	Packing unit/pcs.	Cat. number	Price/100 pieces AUD	Discount group																		
100 x 16	36	⊙ 10	25	318725	273.00 AUD	8																		
100 x 16	60	⊙ 10	25	318726	212.00 AUD	8																		
100 x 16	80	⊙ 10	25	318727	196.00 AUD	8																		
100 x 16	120	⊙ 10	25	324236	196.00 AUD	8																		
115 x 22	36	⊗ 30	25	316490	320.00 AUD	8																		

Backing pads see page 46-47 / Dispenser see page 47

Continuation →

Fibre discs

Coated abrasives

→ Continuation of FS 966 ACT, Abrasive fibre disc, multibond

Diameter x Hole in mm	Grit	Hole pattern	Packing unit/pcs.	Cat. number	Price/100 pieces AUD	Discount group
115 x 22	60	⊗ 30	25	316492	250.00 AUD	8
115 x 22	80	⊗ 30	25	316493	232.00 AUD	8
125 x 22	24	⊗ 30	25	318305	427.00 AUD	8
125 x 22	36	⊗ 30	25	316494	375.00 AUD	8
125 x 22	60	⊗ 30	25	316496	292.00 AUD	8
125 x 22	80	⊗ 30	25	316497	271.00 AUD	8
125 x 22	120	⊗ 30	25	324239	271.00 AUD	8
180 x 22	36	⊗ 30	25	316498	680.00 AUD	8
180 x 22	60	⊗ 30	25	316501	531.00 AUD	8
180 x 22	80	⊗ 30	25	316502	492.00 AUD	8

Backing pad

ST 358



Advantages: Medium-hard backing pad allows good adaptation to the workpiece - For universal use, especially for surface and finish grinding (grit 50 and finer) - High temperature resistance

Diameter in mm	Thread/Shaft	Suitable for	Max. operating speed	Max. RPM	Packing unit/pcs.	Cat. number	Price/piece AUD	Discount group
100	thread M10	Diameter 100 x 16	80 m/s	15300 rpm	1	305190	8.12 AUD	14
100	thread M14	Diameter 100 x 22	80 m/s	15300 rpm	1	2774	10.54 AUD	14
115	thread M14	Diameter 115 x 22	80 m/s	13300 rpm	1	14838	12.02 AUD	14
125	thread M14	Diameter 125 x 22	80 m/s	12200 rpm	1	14835	14.57 AUD	14
180	thread M14	Diameter 180 x 22	80 m/s	8500 rpm	1	14840	29.71 AUD	14

Backing pads see page 46-47 / Dispenser see page 47

Backing pad

ST 358 A



Advantages: For rough grinding - Cool grinding - Increased aggressiveness due to hard, ribbed abrasive surface - High temperature resistance and stability

Diameter in mm	Thread/Shaft	Suitable for	Max. operating speed	Max. RPM	Packing unit/pcs.	Cat. number	Price/piece AUD	Discount group
100	thread M10	Diameter 100	80 m/s	15300 rpm	1	329045	14.31 AUD	14
115	thread M14	Diameter 115 x 22	80 m/s	13300 rpm	1	126346	15.14 AUD	14
125	thread M14	Diameter 125 x 22	80 m/s	12200 rpm	1	126347	18.37 AUD	14
180	thread M14	Diameter 180 x 22	80 m/s	8500 rpm	1	126348	33.22 AUD	14

Dispenser for fibre discs

FS 555



Advantages: Easy stocking and removal of up to 100 fiber discs with diameter of 115 to 180 mm - Orderly and accessible storage at the workplace

Fibre discs not included

Width x Length x Height in mm	Packing unit/pcs.	Cat. number	Price/piece AUD	Discount group
170 x 140 x 196	1	316463	20.27 AUD	14

Sheets with paper backing

Coated abrasives

Abrasive paper, waterproof

PS 11 C



Properties

Bonding agent	Resin
Grain	SiC
Coating	Close
Backing	C-paper

Applications:

Paint/Varnish/Filler	●
Plastic	●
Glass/Stone	◐
Metals	◐

Advantages: Special product for auto repair and painting - For hard and tough surfaces - Good adaptation and high stability - Wet and dry sanding

Available grits:

16	24	30	36	40	50	60	80	100	120	150	180	220	240	280	320	360	400	500	600	800	1000	1200	1500	2000
Width x Length in mm	Grit	Packing unit/pcs.	Cat. number	Price/100 pieces AUD	Discount group																			
230 x 280	60	50	320719	258.00 AUD	5																			
230 x 280	80	50	320667	225.00 AUD	5																			
230 x 280	100	50	320668	198.00 AUD	5																			
230 x 280	120	50	320669	173.00 AUD	5																			
230 x 280	150	50	320670	163.70 AUD	5																			
230 x 280	180	50	320671	154.00 AUD	5																			

Abrasive paper, waterproof

PS 11 A



Properties

Bonding agent	Resin
Grain	SiC
Coating	Close
Backing	A-paper

Applications:

Paint/Varnish/Filler	●
Plastic	●
Glass/Stone	◐
Metals	◐

Advantages: Special product for auto repair and painting - For hard and tough surfaces - Good adaptation and high stability - Wet and dry sanding

Available grits:

16	24	30	36	40	50	60	80	100	120	150	180	220	240	280	320	360	400	500	600	800	1000	1200	1500	2000
Width x Length in mm	Grit	Packing unit/pcs.	Cat. number	Price/100 pieces AUD	Discount group																			
230 x 280	220	50	320672	154.00 AUD	5																			
230 x 280	240	50	320673	154.00 AUD	5																			
230 x 280	280	50	320674	154.00 AUD	5																			
230 x 280	320	50	320675	154.00 AUD	5																			
230 x 280	360	50	320676	154.00 AUD	5																			
230 x 280	400	50	320677	154.00 AUD	5																			
230 x 280	600	50	320678	154.00 AUD	5																			

Other grits and sizes available on request.

Continuation →

Sheets with paper backing

Coated abrasives



→ Continuation of PS 11 A, Abrasive paper, waterproof

Width x Length in mm	Grit	Packing unit/pcs.	Cat. number	Price/100 pieces AUD	Discount group
230 x 280	800	50	320679	163.70 AUD	5
230 x 280	1000	50	320680	163.70 AUD	5
230 x 280	1200	50	320681	163.70 AUD	5
230 x 280	1500	50	320682	163.70 AUD	5
230 x 280	2000	50	320683	163.70 AUD	5

Abrasive paper

PS 33 C



Properties

Bonding agent	Resin
Grain	Aluminium oxide
Coating	Semi-open
Backing	C-paper

Applications:

Paint/Varnish/Filler	●
Wood	●
Plastic	⦿

Advantages: High removal rate - For diverse applications

Available grits:

Width x Length in mm	Grit	Packing unit/pcs.	Cat. number	Price/100 pieces AUD	Discount group
230 x 280	40	50	320684	193.00 AUD	5
230 x 280	60	50	320685	152.90 AUD	5
230 x 280	80	50	320686	133.80 AUD	5
230 x 280	100	50	320687	122.00 AUD	5
230 x 280	120	50	320688	122.00 AUD	5

Other grits and sizes available on request.

Sheets with paper backing

Coated abrasives

Abrasive paper

PS 33 B



Properties

Bonding agent	Resin
Grain	Aluminium oxide
Coating	Semi-open
Backing	B-paper

Applications:

Paint/Varnish/Filler	●
Wood	●
Plastic	○

Advantages: High removal rate - For diverse applications

Available grits:

Width x Length in mm	Grit	Packing unit/pcs.	Cat. number	Price/100 pieces AUD	Discount group
230 x 280	150	50	320689	122.00 AUD	5
230 x 280	180	50	320690	122.00 AUD	5
230 x 280	220	50	327156	123.20 AUD	5
230 x 280	240	50	320691	123.20 AUD	5
230 x 280	280	50	327157	123.20 AUD	5
230 x 280	320	50	320692	123.20 AUD	5
230 x 280	400	50	320693	123.20 AUD	5
230 x 280	600	50	320694	123.20 AUD	5

Abrasive paper, actively coated

PS 73 BW



Properties

Bonding agent	Resin
Grain	Aluminium oxide
Coating	Semi-open
Backing	B-paper

Applications:

Paint/Varnish/Filler	●
Plastic	●

Advantages: High quality product for use on varnish, paint and filler - High removal rate - Substantially reduced clogging and significantly longer service life due to additional special coating

Available grits:

Width x Length in mm	Grit	Packing unit/pcs.	Cat. number	Price/100 pieces AUD	Discount group
230 x 280	180	50	301197	147.40 AUD	5
230 x 280	240	50	301199	149.00 AUD	5
230 x 280	320	50	301201	149.00 AUD	5
230 x 280	400	50	301202	149.00 AUD	5

Other grits and sizes available on request.

Strips with paper backing, self-fastening

Coated abrasives



Abrasive paper, self-fastening

PS 33 CK



Properties

Bonding agent	Resin
Grain	Aluminium oxide
Coating	Semi-open
Backing	C-paper

Applications:

Paint/Varnish/Filler	●
Wood	●
Plastic	⦿

Advantages: High removal rate - For diverse applications

Available grits:

16	24	30	36	40	50	60	80	100	120	150	180	220	240	280	320	360	400	500	600	800	1000	1200	1500	2000
----	----	----	----	----	----	----	----	-----	-----	-----	-----	-----	-----	-----	-----	-----	-----	-----	-----	-----	------	------	------	------

Width x Length in mm	Grit	Hole pattern	Packing unit/pcs.	Cat. number	Price/100 pieces AUD	Discount group
93 x 178	80	GL 17	100	146972	94.90 AUD	7
93 x 178	120	GL 17	100	148046	88.20 AUD	7
115 x 230	80	GL 15	100	146968	140.50 AUD	7
115 x 230	120	GL 15	100	147182	129.70 AUD	7

Abrasive paper, self-fastening

PS 33 BK



Properties

Bonding agent	Resin
Grain	Aluminium oxide
Coating	Semi-open
Backing	B-paper

Applications:

Paint/Varnish/Filler	●
Wood	●
Plastic	⦿

Advantages: High removal rate - For diverse applications

Available grits:

16	24	30	36	40	50	60	80	100	120	150	180	220	240	280	320	360	400	500	600	800	1000	1200	1500	2000
----	----	----	----	----	----	----	----	-----	-----	-----	-----	-----	-----	-----	-----	-----	-----	-----	-----	-----	------	------	------	------

Width x Length in mm	Grit	Hole pattern	Packing unit/pcs.	Cat. number	Price/100 pieces AUD	Discount group
115 x 230	180	GL 15	100	147183	129.70 AUD	7
115 x 230	240	GL 15	100	147184	130.80 AUD	7
115 x 230	320	GL 15	100	147185	130.80 AUD	7

Other grits and sizes available on request.

Non-woven web hand pads

Non-woven web hand pad

NPA 400



Properties

Bonding agent	Resin
Grain	Aluminium oxide

Applications:

Stainless steel	●	Plastic	①
Metals	●		
Wood	●		
Paint/Varnish	①		

Advantages: Outstanding for surface finishing, e.g. adaptation to an existing surface scratch pattern- Can be used wet and dry

Width x Length in mm	Colour	Grade	Packing unit/pcs.	Cat. number	Price/100 pieces AUD	Discount group
152 x 229	maroon	very fine	20	342849	359.49 AUD	5
152 x 229	brown	coarse	20	342852	797.94 AUD	5
152 x 229	dark green	very fine	20	342854	351.81 AUD	5

Non-woven web hand pad

NPA 500



Properties

Bonding agent	Resin
Grain	SiC

Applications:

Paint/Varnish	●	Wood	①
Plastic	●		
Stainless steel	●		
Metals	①		

Advantages: Outstanding for surface finishing, e.g. adaptation to an existing surface scratch pattern - Can be used wet and dry

Width x Length in mm	Colour	Grade	Packing unit/pcs.	Cat. number	Price/100 pieces AUD	Discount group
152 x 229	white	without grain	20	342850	351.81 AUD	5
152 x 229	grey	ultra fine	20	342851	359.49 AUD	5
152 x 229	black	medium	20	342857	364.65 AUD	5

Other grades and sizes available on request.

Abrasive block, flexible, coated on 4 sides

SK 500



Properties

Grain	Aluminium oxide
Coating	Close

Applications:

Paint/Varnish/Filler	●
Wood	●
Plastic	○
Metals	○

Advantages: Can be used flat and upright (four usable sides) - For flat and profiled surfaces due to flexible foam core - Robust, washable and reusable

Available grits:

16	24	30	36	40	50	60	80	100	120	150	180	220	240	280	320	360	400	500	600	800	1000	1200	1500	2000
Width x Length x Height in mm	Grit	Density	Grit color	Foam colour	Packing unit/pcs.	Cat. number	Price/piece AUD	Discount group																
100 x 70 x 25	80	hard	brown	grey	100	225165	1.68 AUD	5																
100 x 70 x 25	120	hard	brown	grey	100	225166	1.68 AUD	5																

Abrasive block, flexible, coated on 4 sides

SK 700 A



Properties

Grain	Aluminium oxide
Coating	Close

Applications:

Paint/Varnish/Filler	●
Wood	●
Plastic	○
Metals	○

Advantages: Suitable for flat or upright use on all four sides - The angled edge (approx. 45°) makes it an exceptional choice for narrow, tapering workpiece contours - Excellent contouring and pressure distribution thanks to flexible foam core - Robust, washable and reusable

Available grits:

16	24	30	36	40	50	60	80	100	120	150	180	220	240	280	320	360	400	500	600	800	1000	1200	1500	2000
Width x Length x Height in mm	Grit	Density	Grit color	Foam colour	Packing unit/pcs.	Cat. number	Price/piece AUD	Discount group																
125 x 89 x 25	60	hard	brown	grey	100	337846	2.75 AUD	5																
125 x 89 x 25	80	hard	brown	grey	100	337847	2.75 AUD	5																
125 x 89 x 25	120	hard	brown	grey	100	331019	2.75 AUD	5																

Other grits and sizes available on request.

Abrasive sponge

Abrasive sponge, flexible, coated on 2 sides

SW 502



Properties

Grain	SiC
Coating	Close

Applications:

Paint/Varnish/Filler	●
Wood	●
Plastic	◐
Metals	◐

Advantages: Glossy surface scratch pattern - For low and high profiled surfaces (two usable sides)
- Crease and break resistant - Washable and reusable

Available grits:

16	24	30	36	40	50	60	80	100	120	150	180	220	240	280	320	360	400	500	600	800	1000	1200	1500	2000
Width x Length x Height in mm	Grit	Density	Grit color	Foam colour	Packing unit/pcs.	Cat. number	Price/piece AUD	Discount group																
123 x 96 x 12,5	120	soft	black	yellow	100	244377	1.55 AUD	5																
123 x 96 x 12,5	220	soft	black	yellow	100	244379	1.55 AUD	5																

Abrasive sponge, flexible, coated on 1 side

SW 510



Properties

Grain	Aluminium oxide
Coating	Close

Applications:

Paint/Varnish/Filler	●
Wood	●
Plastic	◐
Metals	◐

Advantages: Thin, ultra flexible sanding sponge for particularly hard-to-reach areas such as indentations, profiles and edges - Tight foam structure, allowing for exceptionally uniform pressure distribution and an extra fine finish - No bending, no creases - Can be used wet and dry

Available grits:

16	24	30	36	40	50	60	80	100	120	150	180	220	240	280	320	360	400	500	600	800	1000	1200	1500	2000
Width x Length x Height in mm	Grit	Density	Grit color	Foam colour	Packing unit/pcs.	Cat. number	Price/piece AUD	Discount group																
115 x 140 x 5	100	hard	white	grey	100	303588	1.80 AUD	5																
115 x 140 x 5	180	hard	white	grey	100	303589	1.80 AUD	5																
115 x 140 x 5	320	hard	white	grey	100	337849	1.80 AUD	5																

Other grits and sizes available on request.



A large grid of small dots for taking notes.

Discs

Applications guide

Hole patterns for discs

Klingspor offers a wide range of products with hole patterns for dust extraction.

You will find the available hole patterns marked in the table below.

The chart on the following product pages shows the most popular types of machines and the required hole pattern.

GLS 4
 Ø 115 mm
 8 holes Ø 10 mm
 on hole circle Ø 65 mm

GLS 5
 Ø 125 mm
 8 holes Ø 10 mm
 on hole circle Ø 65 mm

GLS 27
 Ø 125 mm
 8 holes Ø 10 mm
 on hole circle Ø 90 mm
 + 1 centre hole Ø 10 mm

Shape 0
 no hole
 different dimensions

Shape 10
 round hole
 different dimensions

Shape 30
 star-shaped hole
 different dimensions

GLS 1
 Ø 150 mm
 8 holes Ø 10 mm
 on hole circle Ø 120 mm
 + 1 centre hole Ø 17 mm

GLS 2
 Ø 150 mm
 8 holes Ø 10 mm
 on hole circle Ø 65 mm

GLS 3
 Ø 150 mm
 6 holes Ø 10 mm
 on hole circle Ø 80 mm

GLS 15
 Triangular Ø 96 mm
 6 holes Ø 8 mm
 on hole circle Ø 52 mm

GLS 24
 98 × 148 mm
 7 holes Ø 10 mm

GLS 47
 Ø 150 mm
 8 holes Ø 9 mm
 on hole circle Ø 120 mm,
 6 holes Ø 9 mm
 on hole circle Ø 80 mm
 + 1 centre hole Ø 17 mm

GLS 51
 Ø 150 mm
 8 holes Ø 10 mm
 on hole circle Ø 120 mm,
 8 holes Ø 8 mm
 on hole circle Ø 65 mm
 + 1 centre hole Ø 10 mm

GLS 74
 Ø 150 mm
 8 holes Ø 9,5 mm
 on hole circle Ø 119 mm,
 16 holes Ø 6 mm
 on hole circle Ø 119 mm
 8 holes Ø 7 mm
 on hole circle Ø 95 mm
 8 holes Ø 8,5 mm
 on hole circle Ø 65 mm
 8 holes Ø 6 mm
 on hole circle Ø 39 mm
 + 1 centre hole Ø 10 mm

GLS 52
 Ø 225 mm
 10 holes Ø 12 mm
 on hole circle Ø 105 mm

Other hole patterns available on request!

Minimum order quantities for made to order items

Type	Ø [mm]	Minimum order quantities
AN 400	bis 50 mm	5.000 pieces
CS 310 X,	bis 90 mm	2.500 pieces
CS 321 X	bis 125 mm	1.000 pieces
CS 411 XK	bis 200 mm	500 pieces
FP 73 WK	bis 400 mm	200 pieces
PS 11 C,	bis 600 mm	100 pieces
PS 19 EK	über 600 mm	25 pieces
PS 21 FK,		
PS 22 F ACT		
PS 22 K,		
PS 33 BK/CK,		
PS 61 FK		
PS 73 BWK/CWK		

Maximum disc diameter

Ø 670 mm	Ø 770 mm	Ø 1.100 mm
PS 21 FK	PS 61 FK	PS 11 C
PS 22 K		PS 19 EK
		PS 33 BK/CK
		FP 73 WK
		PS 73 BWK/CWK
		AN 400
		CS 411 XK
		CS 310 X
		CS 321 X

Orbital and delta sanders

Manufacturer	Type	Size in mm	Hole pattern
AEG powertools	Delta DSE 260	105 × 105 × 105	GLS 17
	FS 2 D	98 × 148	GLS 24
	EX 400, EXE 400, EX 450, EXE 460-125, EX 125 E, EX 125 ES	125	GLS 5
	EXE 450	convertible to 125	GLS 5
	EXE 450	150	GLS 2 (7)
	EXE 460 - 150, ROS 150 E, EX 150 E	150	GLS 3
	EX/E 450	150	GLS 7
Atlas Copco	LST 21 R350, LST 22 R350, LST 22 R325, LST 20 R350	90	GLS 41
	VS 11 D	98 × 148	GLS 24
	LST 30 H90-11	115	blank
	LST 20 R525, LST 20 R550	125	blank
	LST 21 R525, LST 21 R550, LST 22 R525, LST 22 R550	125	GLS 5
	TXE 150	convertible to 125	GLS 5
	LST 20 R625, LST 20 R650, LST 30 H090-15, LST 30 S090-15	150	blank
	ROS 150 E, LST 21 R625, LST 21 R650, LST 22 R625, LST 22 R650, LST31 H90-15, LST31 S90-15, LST32 H090-15, LST32 S090-15, LST 22 R625-9, G2438-6.5N Pro, G2438-6.5I Pro, G2438-6.3I Pro, G2438-6.10I Pro, G2438-6.5C Pro, G2438-6.3N Pro, G2438-6.3C Pro, G2438-6.10N Pro, G2438-6.10C Pro, G2438-10 Velcro 6 Pro, LST 22 R650-9	150	GLS 3
	TXE 150	150	GLS 7
		VP510	96 × 96 × 96
Black & Decker	KA 510	94 × 94 × 94	GLS 15
	KA 165 GT (mouse)		GLS 25
	KA 230 E		GLS 34
	BD190, BD190 E, BD190S, BD190D, XTA90EK, KS 191 EK, KA 198, KA 190, KA 190 E, KA 190 S, KA 198GT, KA220, KA220G, KA191EK	125	GLS 5
Bosch	Delta GDA 280 E, Delta PDA 100, PDA 10-92, Delta PDA 120 E, Delta PDA 240 E, PDA 180, PDA 180 E	96 × 96 × 96	GLS 15
	PEX 11 A, PEX 115, PEX 11 AE	115	GLS 4
	PEX 300 A/AE, GEX 125-150 AVE Professional, PEX 400 AE, PEX 12 A, PEX 12 AE, PEX 125 A-1, PEX 125 AE, PEX 270 A/AE, GEX 125 A, GEX 125 AC, GEX 125-1 AE, PEX 220 A	125	GLS 5
	PEX 15 AE, GEX 150 AE, GEX 150 AC/E, GEX 150 Turbo, PEX 420 AE	150	GLS 3
	ES 55 E, DW423, D26453	125	GLS 5
DeWalt	ES 56 E, ES 56 EK, DW443, D 26410	150	GLS 3
	DE-G 200 E	94 × 94 × 94	GLS 15
Einhell	EX 115	115	GLS 4
	EX-G 125 E, BES 125, EX-G 125, BT-RS 420 E, BES 125 E, BRS 380 E	125	GLS 5
	LL 107 VEA	115	blank
Fein	MSf 636-1, M 10000-5, XS 712	125	GLS 5
	MSf 636-1	150	GLS 26
	MSf 649-2 a/b, M 10000-6	150	GLS 2 (7)
	ROT 14-200 E	150	GLS 2
	X 1107 VE	150	GLS 3
	ROT 14-200 E	200	GLS 9
Felisatti	TP 521/AS, TP 521/E, TP 522 AS/CE, RGF 150/600 E	150	GLS 3

Manufacturer	Type	Size in mm	Hole pattern
Festool	RO 90 DX FEQ-Plus	90	GLS 41
	DS 400, DTS 400	98 × 148	GLS 24
	DX 93	94 × 94 × 94	GLS 16
	ES 125, ES 125 E, ES 125 E-PLUS, ES 125 PLUS	125	GLS 5
	ES 125 EQ-Plus; ES 125 EQ, ES 125 Q-Plus, ES 125 Q, ETS 125, LEX 2 125/3, LEX 1 125/7, LEX 3 125/3, LEX 3 125/5	125	GLS 27
	RO 125 FEQ-Plus	125	GLS 27
	ET 2 E	150	GLS 2
	ET 2 E - Plus, RO 150, RO 150 E, RO 2 E-Plus, LEX 3 150/3, LEX 150, ETS 150/3, ETS 150/5, WTS 150/7 E, WTS 150/7 E-Plus, ETS 150/5 EQ, ETS 150/5 EQ-E, ETS 150/5 EQ-Plus	150	GLS 1
	Multi-Jetstream (8+8+1)	150	GLS 51
	LHS 225 EQ-Plus	225	GLS 38
Flex	OD 100-2, ODE 100-2	98 × 148	GLS 24
	XS 712, XS 713	125	GLS 5
	X 1107 VE, XS 1107 VE	150	GLS 3
	ORE 125-2	125	GLS 27
Hilti	GE 5, GE 5 R, GSE 5 R, WST 700VV, WST 700 VV Plus	225	GLS 52
	WST 700 VV Plus	285	GLS 60
Hitachi	WFE 150, WFE 380, WFE 450 E	150	GLS 3
	FSV 13 Y, TSV 13 Y, SV 13 YA	125	GLS 5
HOLZ HER	SAY 150 A	150	GLS 3
	2445	150	GLS 7 (1)
Kress	CDS 6425, CDS 6420, CDS 6422 E	105	GLS 17
	CPS 6115-1, 6115 E	115	GLS 4
	CPS 6125-1, CPS 6125 E, CPS 6125 E SET, HEX 1385 E, HEX 6385 E, 300 EXE	125	GLS 5
	900 MPS, 900 HEX /2	150	GLS 3
Mafell	UT 150 E, UX 150 E	150	GLS 1, 3, 47
	BO 4561, BO 4565	96 × 96 × 96	GLS 15
Makita	BO 5000, BO 5010, BO 5041, BO 5031 K, BO 5021, BO 5021 K, BO 5041 K	125	GLS 5
	BO 6030, BO 6040 J	150	GLS 1
	DS E 130, DS E 170, DS E 180	96 × 96 × 96	GLS 15
Metabo	DSE 300, DSE 300 Intec, DSE 280 INTEC	94 × 94 × 94	GLS 15
	SXE 400	80	GLS 13
	SX E 125, FSX 200 INTEC, SXE 425 TURBOTECH, SX E 425, SXE 325 INTEC	125	GLS 5
	SX E 425 XL, SX E 450 Duo, SXE 450 TURBOTECH,	150	GLS 3
Milwaukee	PDS 13, FS 2 D	98 × 148	GLS 24
	PRS 125 E	125	GLS 5
Peugeot	ROS 150 E	150	GLS 3
	PAE 115	115	GLS 4
Pro Tool	PRX 150 E	150	GLS 3
	ESP 150 E	150	GLS 3
Ryobi	ERO 2412V, CRO 180M, ROS 300 A, CRO 180 MHG	125	GLS 5
	7110 AA, 7115 AA	96 × 96 × 96	GLS 15
SKIL	7415	115	GLS 4
	7400, 7425, 7430, 7435, 7440 AA, 7460 AA, 7470 MA	125	GLS 5
Stayer	RO 150 E, LRT 150	150	GLS 3
	LRE 84 H, RTE84H	125	GLS 5
Wegoma	RX 91 C, RT188N, RTE46L, RTE146L	150	GLS 3

Please contact Klingspor if you cannot find the machine used by you on this list. We will be pleased to assist you further. If the product you require is not in stock, we will manufacture it for you subject to a minimum order quantity.

Discs with paper backing, self-fastening

Coated abrasives

Abrasive paper, self-fastening

PS 21 FK



Properties

Bonding agent	Resin
Grain	Zirconia alumina
Coating	Close
Backing	F-paper

Applications:

Steel	●
Stainless steel	●
Metals	●

Advantages: Aggressive abrasive behavior due to self-sharpening zirconia alumina - Optimal recipe for rough grinding and finish grinding of stainless steel - Long service life

Available grits:

16 24 30 36 40 50 60 80 100 120 150 180 220 240 280 320 360 400 500 600 800 1000 1200 1500 2000

Diameter in mm	Grit	Hole pattern	Packing unit/pcs.	Cat. number	Price/100 pieces AUD	Discount group
125	40	○ 0	50	246857	195.00 AUD	7
125	60	○ 0	50	237780	157.40 AUD	7
125	80	○ 0	50	237781	139.80 AUD	7
125	120	○ 0	50	237782	128.90 AUD	7
125	240	○ 0	50	237785	129.90 AUD	7
125	320	○ 0	50	237786	129.90 AUD	7
150	40	○ 0	50	230312	262.00 AUD	7
150	60	○ 0	50	230313	209.00 AUD	7
150	80	○ 0	50	230314	184.00 AUD	7
150	120	○ 0	50	246488	169.00 AUD	7
150	150	○ 0	50	239244	169.00 AUD	7
150	180	○ 0	50	252774	169.00 AUD	7
150	240	○ 0	50	251509	171.00 AUD	7
180	80	○ 0	50	256056	260.00 AUD	7

Other grits and sizes available on request.

Discs with paper backing, self-fastening

Coated abrasives



→ Continuation of PS 22 K, Abrasive paper, self-fastening

Abrasive paper, self-fastening

PS 22 K



Properties

Bonding agent	Resin
Grain	Aluminium oxide
Coating	Semi-open
Backing	E-paper

Applications:

Wood	●	Plastic	○
Metals	●		
Stainless steel	○		
Paint/Varnish/Filler	○		

Advantages: Universal abrasive disc for metalworking and woodworking - Uniform surface scratch pattern - Available in many grit sizes and dimensions

Available grits:

Diameter in mm	Grit	Hole pattern	Packing unit/pcs.	Cat. number	Price/100 pieces AUD	Discount group
125	40	○ 0	50	2294	188.00 AUD	7
125	60	○ 0	50	2295	151.90 AUD	7
125	80	○ 0	50	6774	135.10 AUD	7
125	120	○ 0	50	6775	124.40 AUD	7
125	180	○ 0	50	62107	124.40 AUD	7
125	240	○ 0	50	91922	125.50 AUD	7
125	320	○ 0	50	93284	125.50 AUD	7
125	400	○ 0	50	130114	125.50 AUD	7
125	40	⊗ GLS 5	50	89486	188.00 AUD	7
125	60	⊗ GLS 5	50	89488	151.90 AUD	7
125	80	⊗ GLS 5	50	89489	135.10 AUD	7
125	100	⊗ GLS 5	50	89491	124.40 AUD	7
125	120	⊗ GLS 5	50	89493	124.40 AUD	7
125	150	⊗ GLS 5	50	89494	124.40 AUD	7
125	180	⊗ GLS 5	50	89495	124.40 AUD	7
125	240	⊗ GLS 5	50	92753	125.50 AUD	7
125	40	⊗ GLS 27	50	260795	188.00 AUD	7
125	60	⊗ GLS 27	50	260796	151.90 AUD	7
125	80	⊗ GLS 27	50	260797	135.10 AUD	7
125	120	⊗ GLS 27	50	260799	124.40 AUD	7
125	180	⊗ GLS 27	50	260801	124.40 AUD	7
150	40	○ 0	50	20207	251.00 AUD	7
150	60	○ 0	50	6649	202.00 AUD	7
150	80	○ 0	50	6936	177.00 AUD	7
150	120	○ 0	50	6937	162.80 AUD	7
150	150	○ 0	50	71140	162.80 AUD	7
150	180	○ 0	50	4022	162.80 AUD	7
150	240	○ 0	50	91605	164.40 AUD	7
150	320	○ 0	50	91721	164.40 AUD	7
180	40	○ 0	50	2476	354.00 AUD	7
180	60	○ 0	50	2477	283.00 AUD	7

Continuation →

Other grits and sizes available on request.

Discs with paper backing, self-fastening

Coated abrasives

→ Continuation of PS 22 K, Abrasive paper, self-fastening

Diameter in mm	Grit	Hole pattern	Packing unit/pcs.	Cat. number	Price/100 pieces AUD	Discount group
180	80	○ 0	50	6914	250.00 AUD	7
180	120	○ 0	50	6915	228.00 AUD	7
305	60	○ 0	50	226157	881.00 AUD	7
305	80	○ 0	50	201390	784.00 AUD	7

Abrasive paper, self-fastening

PS 33 CK



Properties

Bonding agent	Resin
Grain	Aluminium oxide
Coating	Semi-open
Backing	C-paper

Applications:

Paint/Varnish/Filler	●
Wood	●
Plastic	◐

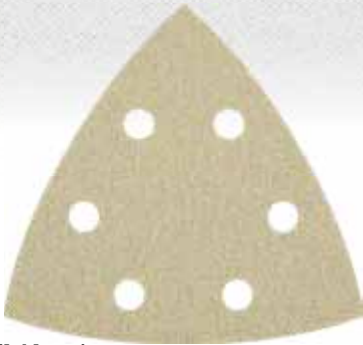

Advantages: High removal rate - For diverse applications

Available grits:

16	24	30	36	40	50	60	80	100	120	150	180	220	240	280	320	360	400	500	600	800	1000	1200	1500	2000
----	----	----	----	----	----	----	----	-----	-----	-----	-----	-----	-----	-----	-----	-----	-----	-----	-----	-----	------	------	------	------

Diameter in mm	Grit	Hole pattern	Packing unit/pcs.	Cat. number	Price/100 pieces AUD	Discount group
96	60	△ GLS 15	100	147164	82.80 AUD	7
96	80	△ GLS 15	100	147165	74.70 AUD	7
96	120	△ GLS 15	100	148195	69.70 AUD	7

Other grits and sizes available on request.

Discs with paper backing, self-fastening

Coated abrasives



Abrasive paper, self-fastening

PS 33 CK



Properties

Bonding agent	Resin
Grain	Aluminium oxide
Coating	Semi-open
Backing	C-paper

Applications:

Paint/Varnish/Filler	●
Wood	●
Plastic	⦿

Advantages: High removal rate - For diverse applications

Available grits:

16	24	30	36	40	50	60	80	100	120	150	180	220	240	280	320	360	400	500	600	800	1000	1200	1500	2000
Width x Length in mm	Grit	Hole pattern	Packing unit/pcs.	Cat. number	Price/100 pieces AUD	Discount group																		
98 x 148	60	⚙️ GLS 24	100	215473	79.50 AUD	7																		
98 x 148	80	⚙️ GLS 24	100	215474	70.10 AUD	7																		
98 x 148	120	⚙️ GLS 24	100	215476	64.30 AUD	7																		

Abrasive paper, self-fastening

PS 33 CK

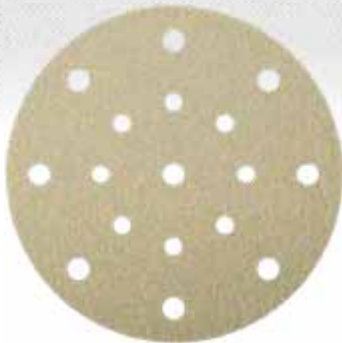

Properties

Bonding agent	Resin
Grain	Aluminium oxide
Coating	Semi-open
Backing	C-paper

Applications:

Paint/Varnish/Filler	●
Wood	●
Plastic	⦿

Advantages: High removal rate - For diverse applications

Available grits:

16	24	30	36	40	50	60	80	100	120	150	180	220	240	280	320	360	400	500	600	800	1000	1200	1500	2000
Diameter in mm	Grit	Hole pattern	Packing unit/pcs.	Cat. number	Price/100 pieces AUD	Discount group																		
125	40	○ 0	100	154113	153.10 AUD	7																		
125	60	○ 0	100	147604	125.30 AUD	7																		
125	80	○ 0	100	149055	112.20 AUD	7																		
125	120	○ 0	100	150433	104.10 AUD	7																		
125	40	⊙ GLS 5	100	146954	153.10 AUD	7																		
125	60	⊙ GLS 5	100	147642	125.30 AUD	7																		
125	80	⊙ GLS 5	100	147643	112.20 AUD	7																		
125	100	⊙ GLS 5	100	147977	104.10 AUD	7																		
125	120	⊙ GLS 5	100	147170	104.10 AUD	7																		
150	40	○ 0	100	147922	204.00 AUD	7																		

Other grits and sizes available on request.

Continuation →

Discs with paper backing, self-fastening

Coated abrasives

→ Continuation of PS 33 CK, Abrasive paper, self-fastening

Diameter in mm	Grit	Hole pattern	Packing unit/pcs.	Cat. number	Price/100 pieces AUD	Discount group
150	60	○ 0	100	147107	163.90 AUD	7
150	80	○ 0	100	146739	145.50 AUD	7
150	100	○ 0	100	147106	134.00 AUD	7
150	120	○ 0	100	146740	134.00 AUD	7
150	40	⊗ GLS 47	100	306836	204.00 AUD	7
150	60	⊗ GLS 47	100	306837	163.90 AUD	7
150	80	⊗ GLS 47	100	305758	145.50 AUD	7
150	100	⊗ GLS 47	100	306838	134.00 AUD	7
150	120	⊗ GLS 47	100	305759	134.00 AUD	7
200	40	○ 0	100	232697	349.00 AUD	7
200	80	○ 0	100	172595	250.00 AUD	7
205	40	⊗ GLS 20	100	220298	363.00 AUD	7
205	80	⊗ GLS 20	100	220300	258.00 AUD	7
205	120	⊗ GLS 20	100	220310	237.00 AUD	7

Abrasive paper, self-fastening

PS 33 BK



Properties

Bonding agent	Resin
Grain	Aluminium oxide
Coating	Semi-open
Backing	B-paper

Applications:

Paint/Varnish/Filler	●
Wood	●
Plastic	⦿



Advantages: High removal rate - For diverse applications

Available grits:

16	24	30	36	40	50	60	80	100	120	150	180	220	240	280	320	360	400	500	600	800	1000	1200	1500	2000
----	----	----	----	----	----	----	----	-----	-----	-----	-----	-----	-----	-----	-----	-----	-----	-----	-----	-----	------	------	------	------

Diameter in mm	Grit	Hole pattern	Packing unit/pcs.	Cat. number	Price/100 pieces AUD	Discount group
125	180	○ 0	100	150435	104.10 AUD	7
125	240	○ 0	100	150460	104.80 AUD	7
125	320	○ 0	100	150461	104.80 AUD	7
125	150	⊗ GLS 5	100	150760	104.10 AUD	7
125	180	⊗ GLS 5	100	147837	104.10 AUD	7
125	240	⊗ GLS 5	100	147838	104.80 AUD	7
125	320	⊗ GLS 5	100	147839	104.80 AUD	7
125	400	⊗ GLS 5	100	147644	104.80 AUD	7
150	180	○ 0	100	146958	134.00 AUD	7
150	240	○ 0	100	146959	135.20 AUD	7
150	320	○ 0	100	146716	135.20 AUD	7
150	400	○ 0	100	147108	135.20 AUD	7
150	150	⊗ GLS 47	100	306839	134.00 AUD	7
150	180	⊗ GLS 47	100	306840	134.00 AUD	7
150	240	⊗ GLS 47	100	306842	135.20 AUD	7
150	320	⊗ GLS 47	100	306844	135.20 AUD	7

Other grits and sizes available on request.

Continuation →

Discs with paper backing, self-fastening

Coated abrasives



→ Continuation of PS 33 BK, Abrasive paper, self-fastening

Diameter in mm	Grit	Hole pattern	Packing unit/pcs.	Cat. number	Price/100 pieces AUD	Discount group
150	400	⊗ GLS 47	100	306846	135.20 AUD	7
150	500	⊗ GLS 47	100	306847	135.20 AUD	7
150	600	⊗ GLS 47	100	306848	135.20 AUD	7
180	180	○ 0	100	262468	188.00 AUD	7
180	240	○ 0	100	262469	189.00 AUD	7
180	320	○ 0	100	263827	189.00 AUD	7
180	400	○ 0	100	294922	189.00 AUD	7
205	180	⊗ GLS 20	100	252721	237.00 AUD	7
205	240	⊗ GLS 20	100	245896	239.00 AUD	7

Abrasive film, active coated, self fastening

FP 73 WK



Properties

Bonding agent	Resin
Grain	Aluminium oxide
Coating	Semi-open
Backing	Film

Applications:

Paint/Varnish/Filler	●
Plastic	⓪



Advantages: Special product with highly tear-resistant film backing for use on paint, varnish and fillers - Very good adaptation of the discs with excellent grit adhesion also in the edge area - Substantially reduced clogging and significantly longer service life

Available grits:

16	24	30	36	40	50	60	80	100	120	150	180	220	240	280	320	360	400	500	600	800	1000	1200	1500	2000
----	----	----	----	----	----	----	----	-----	-----	-----	-----	-----	-----	-----	-----	-----	-----	-----	-----	-----	------	------	------	------

Diameter in mm	Grit	Hole pattern	Packing unit/pcs.	Cat. number	Price/100 pieces AUD	Discount group
150	80	⊗ GLS 47	100	320641	182.00 AUD	7
150	120	⊗ GLS 47	100	320643	168.00 AUD	7
150	150	⊗ GLS 47	100	320644	168.00 AUD	7
150	180	⊗ GLS 47	100	320725	168.00 AUD	7
150	240	⊗ GLS 47	100	320726	169.00 AUD	7
150	320	⊗ GLS 47	100	320727	169.00 AUD	7
150	400	⊗ GLS 47	100	320728	169.00 AUD	7
150	600	⊗ GLS 47	100	320729	169.00 AUD	7
150	800	⊗ GLS 47	100	320730	169.00 AUD	7
150	1200	⊗ GLS 47	100	320732	169.00 AUD	7
150	1500	⊗ GLS 47	100	320733	169.00 AUD	7

Other grits and sizes available on request.

Discs with paper backing, self-fastening

Coated abrasives

Abrasive paper, actively coated,
self-fastening

PS 73 BWK



Properties

Bonding agent	Resin
Grain	Aluminium oxide
Coating	Semi-open
Backing	B-paper

Applications:

Paint/Varnish/Filler	●
Plastic	○

Advantages: High-quality product for use on varnish, paint and filler - High removal rate - Substantially reduced clogging and significantly longer service life due to additional special coating

Available grits:

Diameter in mm	Grit	Hole pattern	Packing unit/pcs.	Cat. number	Price/100 pieces AUD	Discount group
150	150	○ 0	100	301236	144.60 AUD	7
150	180	○ 0	100	301237	144.60 AUD	7
150	240	○ 0	100	301239	145.90 AUD	7
150	320	○ 0	100	301240	145.90 AUD	7
150	400	○ 0	100	301241	145.90 AUD	7
150	500	○ 0	100	301937	145.90 AUD	7
150	600	○ 0	100	306614	145.90 AUD	7
150	800	○ 0	100	301886	145.90 AUD	7
150	1200	○ 0	100	306625	145.90 AUD	7
150	150	⊗ GLS 47	100	301855	144.60 AUD	7
150	180	⊗ GLS 47	100	301856	144.60 AUD	7
150	240	⊗ GLS 47	100	301858	145.90 AUD	7
150	320	⊗ GLS 47	100	301859	145.90 AUD	7
150	400	⊗ GLS 47	100	301860	145.90 AUD	7
150	500	⊗ GLS 47	100	301861	145.90 AUD	7
150	600	⊗ GLS 47	100	301862	145.90 AUD	7
150	800	⊗ GLS 47	100	307051	145.90 AUD	7
150	1200	⊗ GLS 47	100	307053	145.90 AUD	7
205	320	⊗ GLS 20	100	316227	258.00 AUD	7

Other grits and sizes available on request.

Abrasive screen, self-fastening, waterproof

AN 400



Properties

Bonding agent	Resin
Grain	Aluminium oxide
Backing	Polyester screen

Applications:

Paint/Varnish/Filler	●	Composite materials	●
Gel coats	●	Wood	●
Plaster	●	Wood based materials	●
Plasterboard walls	●		

Advantages: Effective and full-surface dust extraction thanks to open grid structure - Dust-free grinding extends the service life of the abrasive - At the same time, improved health and safety thanks to reduced dust formation at the work station - Independent of existing extraction hole patterns - Waterproof

Available grits:

16	24	30	36	40	50	60	80	100	120	150	180	220	240	280	320	360	400	500	600	800	1000	1200	1500	2000
----	----	----	----	----	----	----	----	-----	-----	-----	-----	-----	-----	-----	-----	-----	-----	-----	-----	-----	------	------	------	------

Diameter in mm	Grit	Packing unit/pcs.	Cat. number	Price/100 pieces AUD	Discount group
150	80	50	337886	202.89 AUD	5
150	120	50	337885	200.43 AUD	5
150	180	50	337883	175.51 AUD	5
150	240	50	337888	175.51 AUD	5
150	320	50	337876	175.51 AUD	5
150	400	50	337877	179.26 AUD	5

Multihole backing pad for random orbital sanders

HST 555



Advantages: Very good adhesion for all velour-coated discs due to fine, heat resistant self-fastening coating - For all standard hole patterns, also for netlike and diverse multihole patterns - Compatible with all standard orbital sanders

Diameter in mm	Adaptor	Thread/Shaft	Density	Max. RPM	Packing unit/pcs.	Cat. number	Price/piece AUD	Discount group
150	Festool adaptor	thread M8/ 5/16"	soft	12000 rpm	1	320488	103.09 AUD	14
150	Festool adaptor	thread M8/ 5/16"	medium	12000 rpm	1	320489	103.09 AUD	14
150	Festool adaptor	thread M8/ 5/16"	hard	12000 rpm	1	320587	103.09 AUD	14

Other grits and sizes available on request.

Discs, non-woven web / Backing pads

Backing pad for self-fastening discs

HST 359



Advantages: Good adhesion for all velour-coated abrasive discs - For medium-duty rough grinding and polishing

Diameter in mm	Thread/Shaft	Packing unit/pcs.	Cat. number	Price/piece AUD	Discount group
125	thread M14	1	70434	16.32 AUD	14
150	thread M14	1	327346	33.75 AUD	14
150	thread M14	1	70436	24.31 AUD	14
180	thread M14	1	73066	32.97 AUD	14

Non-woven web disc

NDS 800



Properties

Bonding agent	Resin
Grain	Aluminium oxide
Backing	Non-woven web with polyester lining

Applications:

Metals	●	Wood	ⓘ
Stainless steel	●		
Paint/Varnish/Filler	ⓘ		
Plastic	ⓘ		

Advantages: High edge stability - Aggressive abrasive behaviour - Long service life - Can be used for wet and dry grinding

Available grits:

16 24 30 36 40 50 60 80 100 120 150 180 220 240 280 320 360 400 500 600 800 1000 1200 1500 2000

Diameter in mm	Grit	Colour	Grade	Packing unit/pcs.	Cat. number	Price/100 pieces AUD	Discount group
100	50	brown	coarse	10	258427	629.09 AUD	5
100	100	maroon	medium	10	258428	533.11 AUD	5
100	180	blue	very fine	10	258429	533.11 AUD	5
115	50	brown	coarse	10	258430	852.55 AUD	5
115	100	maroon	medium	10	258431	716.44 AUD	5
115	180	blue	very fine	10	258432	716.44 AUD	5
125	50	brown	coarse	10	258433	993.78 AUD	5
125	100	maroon	medium	10	258434	819.16 AUD	5

Continuation →

Other grades and sizes available on request.

Discs, non-woven web / Backing pads



→ Continuation of NDS 800, Non-woven web disc

Diameter in mm	Grit	Colour	Grade	Packing unit/pcs.	Cat. number	Price/100 pieces AUD	Discount group
125	180	blue	very fine	10	258445	819.16 AUD	5
180	50	brown	coarse	10	262136	1,370.20 AUD	5
180	100	maroon	medium	10	262138	1,162.27 AUD	5
180	180	blue	very fine	10	262140	1,162.27 AUD	5

Backing pad for non-woven web discs

NDS 555



Advantages: Good adhesion for non-woven web discs - For medium-duty rough grinding and polishing

Diameter in mm	Thread/Shaft	Packing unit/pcs.	Cat. number	Price/piece AUD	Discount group
100	thread M10	1	326076	27.68 AUD	14
115	thread M14	1	164100	32.42 AUD	14
125	thread M14	1	208275	35.25 AUD	14
180	thread M14	1	326078	63.52 AUD	14

Other grades and sizes available on request.

Quick Change Discs

Quick Roll Connect

Quick Change Disc

QRC 411



Properties

Bonding agent	Resin
Grain	Zirconia alumina
Coating	Close

Applications:

Stainless steel	●
Metals	●

Advantages: Aggressive abrasive behavior due to self-sharpening zirconia alumina - High removal rate on steel and stainless steel

Available grits:

16 24 30 36 40 50 60 80 100 120 150 180 220 240 280 320 360 400 500 600 800 1000 1200 1500 2000																			
Diameter in mm	Grit	Packing unit/pcs.	Cat. number	Price/100 pieces AUD	Discount group														
50	36	100	295306	172.00 AUD	6														
50	60	100	295309	161.20 AUD	6														
50	80	100	295310	155.00 AUD	6														
50	120	100	295311	153.40 AUD	6														
76	36	50	295318	258.00 AUD	6														
76	60	50	295321	242.00 AUD	6														
76	80	50	295322	232.00 AUD	6														
76	120	50	295323	230.00 AUD	6														

Quick Change Disc

QRC 409

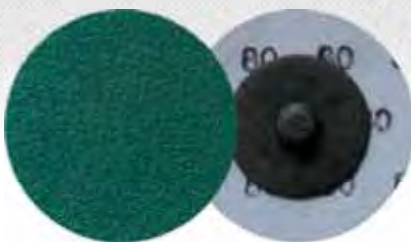
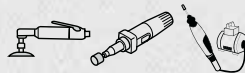

Properties

Bonding agent	Resin
Grain	Zirconia alumina
Coating	Close

Applications:

Stainless steel	●
Metals	●

Advantages: High removal rate on stainless steel - Multibond allows cool grinding on stainless steel - Minimal clogging on aluminium

Available grits:

16 24 30 36 40 50 60 80 100 120 150 180 220 240 280 320 360 400 500 600 800 1000 1200 1500 2000																			
Diameter in mm	Grit	Packing unit/pcs.	Cat. number	Price/100 pieces AUD	Discount group														
50	36	100	295340	193.00 AUD	6														
50	60	100	295343	181.00 AUD	6														
50	80	100	295344	174.00 AUD	6														
50	120	100	295345	172.00 AUD	6														

Continuation →

Other grits and sizes available on request.

Quick Change Discs

Quick Roll Connect



→ Continuation of QRC 409, Quick Change Disc

Diameter in mm	Grit	Packing unit/pcs.	Cat. number	Price/100 pieces AUD	Discount group
76	36	50	295351	289.00 AUD	6
76	60	50	295354	271.00 AUD	6
76	80	50	295355	261.00 AUD	6
76	120	50	298976	258.00 AUD	6

Quick Change Disc

QRC 800



Properties

Bonding agent Resin	
Grain	Aluminium oxide

Applications:

Metals	●
Paint/Varnish/Filler	⓪



Advantages: For light deburring - For removal of rust and paint - Long life due to hard, stable quality of non-woven web material

Diameter in mm	Grit	Colour	Grade	Packing unit/pcs.	Cat. number	Price/100 pieces AUD	Discount group
50	50	brown	coarse	50	295413	307.00 AUD	5
50	100	maroon	medium	50	295414	292.00 AUD	5
50	180	blue	very fine	50	295415	269.00 AUD	5
76	50	brown	coarse	25	295419	460.00 AUD	5
76	100	maroon	medium	25	295420	438.00 AUD	5
76	180	blue	very fine	25	295421	403.00 AUD	5

Grit		60 - 80	120 - 150	180 - 240
Grade		coarse	medium	very fine
Klingspor Quick Change Discs	Aggressiveness decreasing ↓	coarse A - brown		
			medium A - maroon	
				very fine - blue

Other grits and sizes available on request.

Backing pad / Adapter

Backing pad

QRC 555

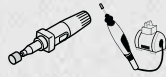

Advantages: For secure mounting of QRC discs - Optimized abrasive properties (aggressiveness, surface quality) due to two hardnesses

Diameter x Shaft in mm	Density	Colour	Max. RPM	Packing unit/pcs.	Cat. number	Price/piece AUD	Discount group
50 x 6	medium	blue	30000 rpm	1	295428	21.80 AUD	14
50 x 6	firm	red	30000 rpm	1	295429	27.37 AUD	14
76 x 6	medium	blue	20000 rpm	1	295432	26.16 AUD	14
76 x 6	firm	red	20000 rpm	1	295433	30.25 AUD	14

Adapter for quick change discs

QCA 555



Advantages: Quick Change Disc adapter with M14 thread - Allows use of quick change discs on a regular angle grinder

Width x Length in mm	Thread/Shaft	Max. operating speed	Max. RPM	Packing unit/pcs.	Cat. number	Price/piece AUD	Discount group
20 x 30	thread M14	80 m/s	75400 rpm	1	308693	15.17 AUD	14



A large grid of small dots for taking notes.



Abrasive mop wheels

About the product

Developed by Klingspor over 40 years ago the abrasive mop wheel has found many practical and economical uses in surface finishing work. The Klingspor abrasive mop wheel comprises of high quality grinding flaps coated with aluminium oxide. The fan-shaped radial arrangement is firmly anchored by a resin core at the centre of the abrasive mop wheel. The structure of the abrasive mop wheel provides for very soft, comfortable grinding behaviour and adapts optimally to the contours of the workpiece. Klingspor abrasive mop wheels are especially suited for achieving a very smooth surface finish.

Klingspor has the perfect abrasive mop wheel to suit every surface, ranging from even to profiled surfaces, and is suited for nearly every material.

Machines:

Klingspor abrasive mop wheels can, depending on the dimensions, be used with the following machines:



Die grinders



Angle grinders



Flexible shafts



Drilling machines



Floor stand grinders



Satin finishing machine

Type	Material applications																Machine applications					
	Metal	Apparatus/ container engineering	Precision engineering	Mould making	Fittings	Pipes	Profiled sections	Tools	Mountings	Cutlery	Wood	Contoured wood	Model construction	Profiled sections	Paint / varnish / fillers	Plastics	Flexible shafts	Drilling machines	Die grinders	Automatic grinders	Floor stand grinders	Angle grinders
SM 611	●	●	●	●	●	●	●	●	●	●	●	●	●	●	●	●		●	●	●	●	
SM 611 W	●	●	●	●	●	●	●	●	●	●	●	●	●	●	●	●		●	●	●	●	
SM 611 H	●	●	●	●	●	●	●	●	●	●	●	●	●	●	●	●		●	●	●	●	
MM 630	●	○		○		○	○				●	●	●	●	●	○	●	●				
MM 650	●	●	○	○	○	○	●		○		●	●	●	●	●	○	●	●	●		●	
WSM 617	●	●	●	●	●	●	●	●	●	●	○	○	●	●	●	●	○					●
FSR 618	●	○	●	●	●	●	●	●	●	●	○	○	○	○	○	○	●			●	●	
NCW 600 H	●	●	●	●	●	●	●	●	●	●						○	●	●				
NFW 600 H	●	●	●	●	●	●	●	●	●	●												

● = main application ○ = possible application

Abrasive mop wheels

Applications guide

Mounting

Abrasive mop wheels SM 611, MM 650, Abrasive cloth mop wheels NCW/NFW 600

These abrasive mop wheels are mounted to the machine spindle with two SMD 612 mounting plates.

Correct mounting is important!

To ensure that the abrasive mop wheel runs smoothly, please check that the mounting plates are mounted evenly and fit tightly to the inner edge of the metal side mounting plate retaining groove. The mounting plates are equipped with mounting bore holes. Making bore hole adjustments to fit the respective shaft diameter easy and quick – by simply drilling the appropriate bore hole diameter. Please refer to product text SMD 612 for more information on maximum bore hole diameters.

The special abrasive mop and finishing mop models listed below are designed in such a way that they can be fitted on top of the respective machine shafts without any additional SMD 612 clamping brackets.

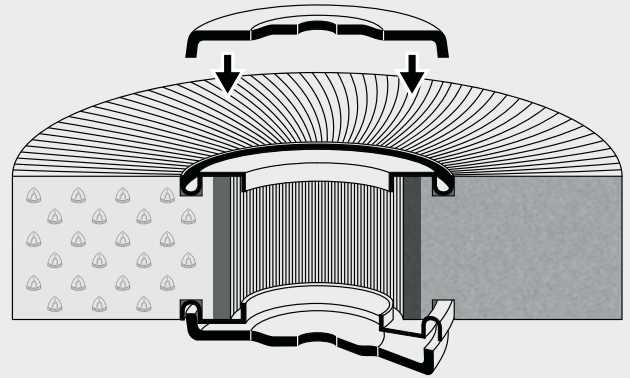

Abrasive mop wheel SM 611 H

The abrasive mop wheel with a wooden core is preferred for work on floor stand grinders with cone shaped mounting spindles. It can be mounted directly on the machine spindle without the use of a mounting plate. Abrasive mop wheel SM 611 H is equipped with a \varnothing 13 mm bore hole. Making bore hole adjustments to fit the respective shaft diameter easy and quick - by simply drilling the appropriate bore hole diameter.



Abrasive mop wheel SM 611 W

This abrasive mop wheel is equipped with a \varnothing 25.4 mm mounting bore hole and can be mounted to a machine without the use of a mounting plate.



WSM 617

WSM 617 is a second generation abrasive mop wheel with integrated M14 and 5/8" internal threads. This wheel can be mounted and demounted to an angle grinder without the use of any additional tools.



Abrasive flap drum SM 611 S, Abrasive mop drum NCW / NFW 600 S

These drums are equipped with mounting bore holes starting from 19 mm for all standard satin finishing machines with the corresponding machine spindles.

Abrasive mop wheels

Applications guide



Minimum order quantities for made to order items

Product	Diameter in mm	Minimum order quantities
SM 611	100–165	20 pieces
SM 611 W/H/S*	200–300	10 pieces
WSM 617*	350–410	4 pieces
	100–165	20 pieces
NFW 600 / NCW 600	200–300	10 pieces
	350–410	4 pieces

* Available dimensions on request

Product	Diameter in mm	Minimum order quantities
	165	20 pieces
FSR 618	200–300	10 pieces
	350–400	4 pieces
	100–165	20 pieces
MM 650	200–300	10 pieces
	>300	4 pieces

The surface scratch pattern

The abrasive mop wheel's construction makes it perfect for achieving a smooth surface finish.

The abrasive mop wheel achieves a significantly smoother surface finish compared to that of a belt grinder. When choosing a grit size please select a grit size that is 2-3 sizes rougher than that used with a belt grinder.



Abrasive belt 40 grit

- ▶ short distinctive line pattern
- ▶ rough surface
- ▶ high contrast finish



Abrasive mop wheel 40 grit

- ▶ long continuous line pattern
- ▶ minimum depression
- ▶ smooth finish

Common profilings

Pre-profiled abrasive mop wheels are designed to adapt perfectly to the contours of your individual workpiece and provide excellent results from the very beginning. Time consuming pre-profiling of the abrasive mop is no longer needed.

If you require an individualised abrasive mop wheel, we would be pleased to assist you with this.

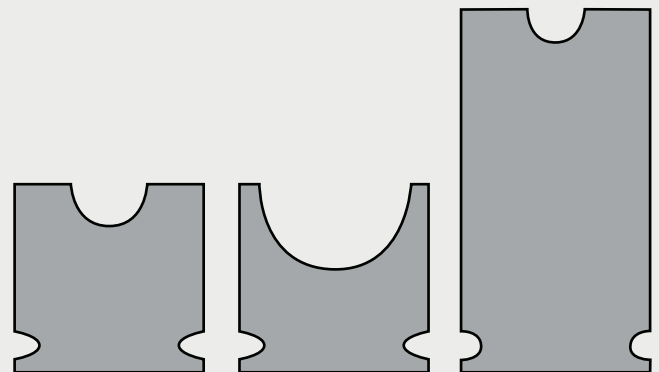

Abrasive mop wheels

Applications guide

Selection of the correct mop diameter

To be able to work at the optimal cutting rate (38-42 m/s) the selection of the abrasive mop diameter for machines, that are not equipped with RPM setting functionality, is based on the set RPM. Machines that are equipped with RPM setting functionality are to be set according to the abrasive mop wheel diameter settings.

Attention! Before turning the machine on please check that the pre-set RPM does not exceed the maximum abrasive mop RPM setting.

Please refer to the adjoining table for the correct abrasive mop diameter settings for the optimal RPM range.

If the abrasive mop wheel is used at the optimal RPM setting, the grinding flaps stand up straight as result of the centrifugal forces around the core and provide optimum abrasive mop wheel grinding properties. Only the edges of the grinding flaps are subjected to wear and tear. This results in the use of new and sharper grits. This ensures uniform stock removal and surface finish – from the first to the last workpiece.

Suboptimal RPM settings (too low) result in the incorrect positioning of the grinding flap as a result of tool / grinding pressure. This results in wear and tear on the grit side of the grinding flaps, and the area the abrasive mop wheel grinds is too large, which in turn results in higher friction between the workpiece and the grinding flaps. Consequently the workpiece and abrasive mop wheel are subjected to a higher thermal load and a higher degree of wear and tear on the grinding flaps. Ultimately, this can result in the failure of the abrasive mop wheel and damaged grinding flaps.

Maximum RPM:

Klingspor SM 611 abrasive mop wheels are certified for widths of ≤ 100 mm and maximum revolutions per minute of 50 m/s.

Optimal cutting rate:

The abrasive mop wheel's optimum performance range is a cutting rate between 38-42 m/s.

Mop-ø [mm]	Recommended RPM range [min-1] (38 - 42 m/s)
100	7,300–8,000
140	5,200–5,700
165	4,400–4,800
200	3,650–4,000
250	2,900–3,200
300	2,400–2,650
350	2,100–2,300
380	1,900–2,100
410	1,750–1,950
480	1,500–1,650
510	1,400–1,550

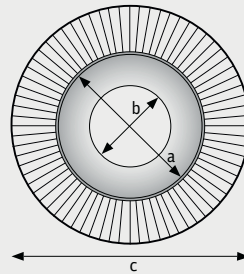

- a Outer diameter side cover
- b Hole side cover
- c Outer diameter mop

Mop side cover and hole relative to the outer mop diameter*

Type	Mop wheel outer Ø [mm]	Metal side cover		Matching clamping flange SMD 612
		Outer Ø [mm]	Hole [mm]	
SM 611	100 - 140	60	21,0	14821
	150 - 165	82	43,1	14823
	200 - 250	125	68,2	14824
	300	158	97,8	14826
	350	198	131,8	14827
	380 - 410	224	151,6	14829
	480 - 510	332	244,5	-
MM 650	250	82	43,1	14823
NCW/NFW 600	165	82	43,1	14823
	200	125	68,2	14824

* applies to standard versions (stock items)

Abrasive mop wheels

Applications guide



Packet assembling

Another way to influence the grinding result is packet assembling. During packet assembling an intermediate layer is stamped between the cloth flaps. This creates space between the individual flaps, which influences the grinding behaviour of the wheel. The higher the ratio of grinding flaps to intermediate layers, the harder the abrasive mop wheel.

The standard abrasive mop wheel is manufactured without packet assembling.

Exception: Starting at a diameter of ≥ 250 mm, a width of ≥ 50 mm, and a grit size of 220 and finer, abrasive mop wheels are manufactured with a packet assembly ratio of 5:1.



5:1



3:1

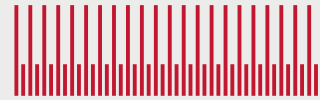

1:1

Factors influencing the grinding result

The surface finish is dependent upon a wide range of process parameters. The table below illustrates the different influencing factors and their affect on the grinding result.

Influencing factor	Grinding result			
		Stock removal*	Surface finish	Service life
Cutting rate	high	increases	finer	shorter
	low	decreases	rougher	longer
Tool / grinding pressure	high	increases	rougher	shorter
	marginal	decreases	finer	longer
Grit size	rough	increases	rougher	shorter
	fine	decreases	finer	longer
Grinding aids (oils, lubricants)	without	increases	rougher	shorter
	with	decreases	finer	longer

* Note: the essential parameters that affect the stock removal rate are the selection of a rougher (more stock removal) or finer (less stock removal) grit.

The safe use of Klingspor abrasives

Klingspor abrasive mops are manufactured in accordance with the oSa and EN 13743 standards, this ensures the highest level of user safety.



Wear safety goggles or glasses to protect the eyes



Wear safety gloves to protect hands



Wear a dust mask



Observe safety instructions



Use ear muffs



Do not use for wet grinding

Abrasive mop wheels

Abrasive mop

Abrasive mop

SM 611

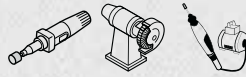

Properties

Bonding agent	Resin
Grain	Aluminium oxide

Applications:

Paint/Varnish/Filler	●
Wood	●
Plastic	●
Metals	●

Advantages: Even surface scratch pattern due to continuously fresh, unused abrasive grit - For universal use on all materials - Adapts optimally to workpiece contour

Available grits:

16	24	30	36	40	50	60	80	100	120	150	180	220	240	280	320	360	400	500	600	800	1000	1200	1500	2000
Diameter x Width x Bore in mm	Grit	Max. operating speed	Max. RPM	Packing unit/pcs.	Cat. number	Price/piece AUD	Discount group																	
165 x 50 x 43,1	60	50 m/s	5800 rpm	3	12107	96.57 AUD	9																	
300 x 50 x 97,8	80	50 m/s	3200 rpm	1	12288	418.55 AUD	9																	
300 x 50 x 97,8	120	50 m/s	3200 rpm	1	12290	418.55 AUD	9																	

Use only with mounting plate SMD 612!

Mounting plate

SMD 612



Advantages: Ensures a smooth running and the safe mounting on the machine

Diameter x Bore in mm	Suitable for	Max. enlargement of bore Ø in mm	Packing unit/pcs.	Cat. number	Price/piece AUD	Discount group
79 x 12	SM 611/NCW/NFW 600 (Ø150+Ø165)	Ø 40 mm	2	14823	10.27 AUD	14
155 x 20	SM 611 (Ø300)	Ø 50 mm	2	14826	16.75 AUD	14

Other grits and sizes available on request.

Abrasive mop wheels

Abrasive mop



Abrasive mop

SM 611 H



Properties

Bonding agent Resin	
Grain	Aluminium oxide

Applications:

Paint/Varnish/Filler	●
Wood	●
Plastic	●
Metals	●

Advantages: Wooden core with mounting bore diameter of 13 mm for fast mounting - Can be used without mounting plate SMD 612 - Enlargement of the mounting bore is relatively uncomplicated

Available grits:

16 24 30 36 40 50 60 80 100 120 150 180 220 240 280 320 360 400 500 600 800 1000 1200 1500 2000																				
Diameter x Width x Bore in mm	Grit	Max. operating speed	Max. RPM	Packing unit/pcs.	Cat. number	Price/piece AUD	Discount group													
165 x 25 x 13	40	50 m/s	5800 rpm	5	10030	63.79 AUD	9													
165 x 25 x 13	60	50 m/s	5800 rpm	5	10005	63.79 AUD	9													
165 x 25 x 13	120	50 m/s	5800 rpm	5	10006	69.85 AUD	9													
165 x 25 x 13	240	50 m/s	5800 rpm	5	10027	103.87 AUD	9													
165 x 50 x 13	40	50 m/s	5800 rpm	3	10022	96.57 AUD	9													
165 x 50 x 13	60	50 m/s	5800 rpm	3	10017	110.95 AUD	9													
165 x 50 x 13	80	50 m/s	5800 rpm	3	10018	115.48 AUD	9													
165 x 50 x 13	120	50 m/s	5800 rpm	3	15990	132.63 AUD	9													

Pleated mop

FSR 618

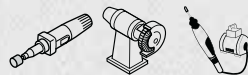

Properties

Bonding agent Resin	
Grain	Aluminium oxide

Applications:

Metals	●
Wood	⊖
Paint/Varnish/Filler	⊖
Plastic	⊖

Advantages: Pleated mop wheel consisting of pleated aluminum oxide cloth flaps allows easy access to joints, grooves and slots - Very large immersion depth

Available grits:

16 24 30 36 40 50 60 80 100 120 150 180 220 240 280 320 360 400 500 600 800 1000 1200 1500 2000																				
Diameter x Bore in mm	Grit	Max. operating speed	Max. RPM	Packing unit/pcs.	Cat. number	Price/piece AUD	Discount group													
165 x 14	80	50 m/s	5800 rpm	10	5831	111.46 AUD	9													
165 x 14	120	50 m/s	5800 rpm	10	73994	111.46 AUD	9													
165 x 14	240	50 m/s	5800 rpm	10	26041	111.46 AUD	9													

Other grits and sizes available on request.

Abrasive mop wheels

Abrasive mop

Angle grinder mop

WSM 617



Properties

Bonding agent	Resin
Grain	Aluminium oxide

Applications:

Steel	●	Wood	●
Stainless steel	●		
Paint	●		
Plastic	●		

Advantages: Can be used on all standard angle grinders (80 m/s) - For universal use; in front and side position - Easy tool changing by hand without additional aids

Available grits:

16	24	30	36	40	50	60	80	100	120	150	180	220	240	280	320	360	400	500	600	800	1000	1200	1500	2000
Diameter x Width in mm	Grit	Thread/Shaft	Max. operating speed	Max. RPM	Packing unit/pcs.	Cat. number	Price/piece AUD	Discount group																
125 x 20	40	thread M14	80 m/s	12200 rpm	2	277018	44.63 AUD	9																
125 x 20	60	thread M14	80 m/s	12200 rpm	2	277019	44.63 AUD	9																
125 x 20	80	thread M14	80 m/s	12200 rpm	2	277020	47.15 AUD	9																
125 x 20	120	thread M14	80 m/s	12200 rpm	2	277021	47.15 AUD	9																

Abrasive mop

NCW 600 H

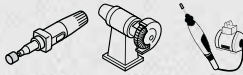

Properties

Bonding agent	Resin
Grain	Aluminium oxide

Applications:

Stainless steel	●
Metals	●
Plastic	○

Advantages: A combination of non-woven web and abrasive cloth for an extra fine scratch pattern on metal surfaces

Diameter x Width x Bore in mm	Grit	Grade	Colour	Max. operating speed	Max. RPM	Packing unit/pcs.	Cat. number	Price/piece AUD	Discount group
165 x 50 x 13	80	coarse	maroon	32 m/s	3700 rpm	3	308583	105.70 AUD	9
165 x 50 x 13	100	medium	maroon	32 m/s	3700 rpm	3	308584	105.70 AUD	9
165 x 50 x 13	150	medium	maroon	32 m/s	3700 rpm	3	308585	105.70 AUD	9

Other grits and sizes available on request.

Finishing mop

Abrasive mop



Nylon webbed mop

NFW 600 H

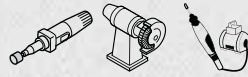

Properties

Bonding agent	Resin
Grain	Aluminium oxide

Applications:

Metals	●
Stainless steel	●

Advantages: Abrasive mop wheel for mat, satin and final finishing of metal surfaces

Diameter x Width x Bore in mm	Grade	Colour	Max. operating speed	Max. RPM	Packing unit/pcs.	Cat. number	Price/piece AUD	Discount group
165 x 50 x 13	coarse	maroon	32 m/s	3700 rpm	3	308586	97.02 AUD	9
165 x 50 x 13	medium	maroon	32 m/s	3700 rpm	3	308587	97.02 AUD	9
165 x 50 x 13	very fine	maroon	32 m/s	3700 rpm	3	308588	97.02 AUD	9

Other grits and sizes available on request.

Satin finishing drums

Satin finishing drum

SM 611 S



Properties

Bonding agent	Resin
Grain	Aluminium oxide

Applications:

Paint/Varnish/Filler	●
Wood	●
Plastic	●
Metals	●

Advantages: Even surface scratch pattern - Special product for fine surface finishing

Available grits:

16	24	30	36	40	50	60	80	100	120	150	180	220	240	280	320	360	400	500	600	800	1000	1200	1500	2000
Diameter x Width x Bore in mm	Grit	Max. operating speed	Max. RPM	Packing unit/pcs.	Cat. number	Price/piece AUD	Discount group																	
100 x 100 x 19	40	19 m/s	3700 rpm	1	83167	127.34 AUD	9																	
100 x 100 x 19	60	19 m/s	3700 rpm	1	7325	127.34 AUD	9																	
100 x 100 x 19	80	19 m/s	3700 rpm	1	7326	139.43 AUD	9																	

Satin finishing drum

NCW 600 S



Properties

Bonding agent	Resin
Grain	Aluminium oxide

Applications:

Stainless steel	●
Metals	●
Plastic	○

Advantages: High removal rate and fine surface scratch pattern due to combination of non-woven and abrasive cloth flaps - Long service life

Diameter x Width x Bore in mm	Grit	Grade	Colour	Max. operating speed	Max. RPM	Packing unit/pcs.	Cat. number	Price/piece AUD	Discount group
110 x 100 x 19	80	coarse	maroon	19 m/s	3300 rpm	1	320246	99.68 AUD	9
110 x 100 x 19	100	medium	maroon	19 m/s	3300 rpm	1	320247	99.68 AUD	9
110 x 100 x 19	150	medium	maroon	19 m/s	3300 rpm	1	320248	99.68 AUD	9
110 x 100 x 19	180	very fine	maroon	19 m/s	3300 rpm	1	320249	99.68 AUD	9

Other grits and sizes available on request.

Satin finishing drum

NFW 600 S



Properties

Bonding agent	Resin
Grain	Aluminium oxide

Applications:

Metals	●
Stainless steel	●

Advantages: Even finish throughout the entire service life - Optimal tool with high quality non-woven flaps for creating a matt or satin finish

Diameter x Width x Bore in mm	Grade	Colour	Max. operating speed	Max. RPM	Packing unit/pcs.	Cat. number	Price/piece AUD	Discount group
110 x 100 x 19	coarse	maroon	19 m/s	3300 rpm	1	320253	97.33 AUD	9
110 x 100 x 19	medium	maroon	19 m/s	3300 rpm	1	320254	97.33 AUD	9
110 x 100 x 19	very fine	maroon	19 m/s	3300 rpm	1	320255	97.33 AUD	9

Other grits and sizes available on request.

Small abrasive mops

About the product

The small abrasive mop comprises of grinding flaps coated with aluminium oxide. The fan-shaped abrasive flaps are securely fixed to a central mounting spindle. The grinding flaps' fan-shaped radial arrangement adapts perfectly to the contours of the workpiece.

The wide range of grits (40 – 320) and top size coat additives (with and without multibonds) make the Klingspor small abrasive mop perfect for a wide range of applications.

The small abrasive mop is equipped with the following standard features: a 6 mm or 3 mm fixing spindle and a shaft length of 40 mm.

Application examples

- ▶ Grinding work for tool and mould making
- ▶ Processing of profiled workpieces
- ▶ Processing of internal surfaces on pipework, fittings and difficult-to-reach areas
- ▶ Grinding work on small parts and casing

Type	Material applications														Machine applications			
	Metal	Apparatus / container engineering	Precision engineering	Mould making	Fittings	Pipes	Profiled sections	Tools	Mountings	Cutlery	Wood	Contoured wood	Model construction	Profiled sections	Plastics	Flexible shafts	Drilling machines	Die grinders
<i>KM 613</i>	●	●	●	●	●	●	●	●	●	●	○	○	○	○	○	●	●	●
<i>KM 615</i>	●	●	●	●	●	●	●	●	●	●			○	○		●	●	●
<i>KMT 614</i>	●	●	●	●	●	●	●	●	●	●	○	○	○	○	○	●	●	●
<i>NCS 600</i>	●	●	●	●	●	●	●	●	●	●					○	●	●	●
<i>NFS 600</i>	●	●	●	●	●	●	●	●	●	●						●	●	●

● = main application ○ = possible application

Minimum order quantities for made to order items

Product	Grit	Minimum order quantities
<i>KM 613</i>	40–320	250 pieces
	from 360	500 pieces
<i>KM 615</i>	40–180	250 pieces

Product	Grit	Minimum order quantities
<i>KMT 614</i>	40–320	250 pieces
	from 360	500 pieces
Product	Diameter in mm	Minimum order quantities
<i>NCS 600/ NFS 600</i>	30, 40, 50, 60	150 pieces
	80, 100	100 pieces

Small abrasive mops

Applications guide



Application recommendations

- ▶ The small abrasive mop can be used with flexible shaft grinders, die grinders (pneumatic, electric) or drilling machines.
- ▶ The small abrasive mop's optimum performance is achieved at a cutting rate between 20 – 25 m/s. By observing these speeds, the product will perform at its most economical as regards tool wear, stock removal, surface finish and thermal load of the workpiece.

Factors influencing the grinding result

Stock removal:

An increase in stock removal should only occur as a result of using rougher grit and not as a result of increased tool / grinding pressure.

Steady increased tool / grinding pressure

- ▶ results in unnecessary tool wear and tear
- ▶ results in increased workpiece temperature load
- ▶ can result in tool failure

Surface finish:

- ▶ The wear of the outer edge of the grinding flaps results in the presentation of new sharp abrasive grain, which results in a uniform surface finish
- ▶ The surface roughness decreases through an increase in the cutting rate
- ▶ An increase in the tool / grinding pressure results in a coarser surface roughness
- ▶ The small abrasive mop achieves a significantly smoother surface finish compared to that of a belt grinder

Temperature load:

- ▶ By reducing the tool / grinding pressure and the peripheral speeds the temperature load of the workpiece and the tool is reduced.

ø [mm]	Height [mm]	Maximum operating speed [m/s]*	RPM [1/min]		
			L ₀ = 0 mm	L ₀ = 10 mm	L ₀ = 20 mm
10	≤ 15	40	76.300	55.000	35.000
15	≤ 25	40	50.500	37.000	28.000
20	≤ 20	40	38.150	28.600	21.900
25	≤ 15	40	30.500	22.900	17.500
30	≤ 15	40	25.400	19.000	14.600
40	≤ 20	40	19.000	14.300	10.900
50	≤ 30	40	15.200	11.400	8.700
60	≤ 40	40	12.700	9.500	7.300
	50	32	10.150	7.900	6.300
80	≤ 40	40	9.500	7.100	5.400
	50	32	7.650	6.000	4.800

* for exposed shank length L₀=0 mm

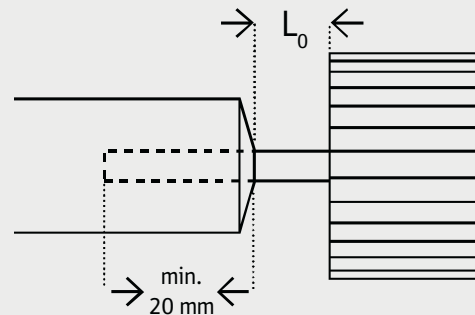

Tool wear

Tool wear is reduced by working with a lower grinding pressure.

To ensure the optimal and most efficient use of a tool

- ▶ the maximum revolutions per minute may not be exceeded
- ▶ the fixing spindle length of the small abrasive mop in the mounting device must be at least 20 mm
- ▶ the set revolutions per minute may not be exceeded when using an exposed shaft length L₀ (please refer to the table above)

For additional information please refer to the safety information provided with the product.

Small abrasive mop

Abrasive mop

Small abrasive mop

KM 613

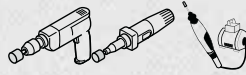

Properties

Bonding agent	Resin
Grain	Aluminium oxide

Applications:

Stainless steel	●
Metals	●
Wood	◐
Plastic	◐

Advantages: Universal product for steel and stainless steel materials - Even removal rate - Suitable for use in hard-to-reach areas

Available grits:

Diameter x Width x Shaft in mm		Grit	Max. operating speed	Max. RPM	Packing unit/pcs.	Cat. number	Price/piece AUD	Discount group																
16	24	30	36	40	50	60	80	100	120	150	180	220	240	280	320	360	400	500	600	800	1000	1200	1500	2000
20 x 10 x 6		60	40 m/s	38150 rpm	25	284730	6.45 AUD	9																
20 x 10 x 6		80	40 m/s	38150 rpm	25	284731	6.45 AUD	9																
20 x 10 x 6		120	40 m/s	38150 rpm	25	284732	6.48 AUD	9																
20 x 15 x 6		60	40 m/s	38150 rpm	25	284737	6.58 AUD	9																
25 x 10 x 6		60	40 m/s	30500 rpm	10	253591	6.36 AUD	9																
25 x 15 x 6		60	40 m/s	30500 rpm	10	250985	6.95 AUD	9																
25 x 15 x 6		80	40 m/s	30500 rpm	10	237496	6.95 AUD	9																
30 x 10 x 6		40	40 m/s	25400 rpm	10	12816	6.72 AUD	9																
30 x 10 x 6		60	40 m/s	25400 rpm	10	12817	6.72 AUD	9																
30 x 10 x 6		80	40 m/s	25400 rpm	10	12818	6.72 AUD	9																
30 x 10 x 6		120	40 m/s	25400 rpm	10	12820	6.79 AUD	9																
30 x 15 x 6		40	40 m/s	25400 rpm	10	12843	7.35 AUD	9																
30 x 15 x 6		60	40 m/s	25400 rpm	10	12844	7.35 AUD	9																
30 x 15 x 6		80	40 m/s	25400 rpm	10	12845	7.35 AUD	9																
30 x 15 x 6		100	40 m/s	25400 rpm	10	12846	7.38 AUD	9																
30 x 15 x 6		120	40 m/s	25400 rpm	10	12847	7.38 AUD	9																
40 x 10 x 6		60	40 m/s	19000 rpm	10	12871	7.35 AUD	9																
40 x 10 x 6		80	40 m/s	19000 rpm	10	12872	7.35 AUD	9																
40 x 10 x 6		120	40 m/s	19000 rpm	10	12874	7.38 AUD	9																
40 x 15 x 6		40	40 m/s	19000 rpm	10	12906	7.57 AUD	9																
40 x 15 x 6		60	40 m/s	19000 rpm	10	12907	7.57 AUD	9																
40 x 15 x 6		80	40 m/s	19000 rpm	10	12908	7.57 AUD	9																
40 x 15 x 6		120	40 m/s	19000 rpm	10	12910	7.62 AUD	9																
40 x 20 x 6		40	40 m/s	19000 rpm	10	12942	7.92 AUD	9																
40 x 20 x 6		60	40 m/s	19000 rpm	10	12943	7.92 AUD	9																
40 x 20 x 6		80	40 m/s	19000 rpm	10	12944	7.92 AUD	9																
40 x 20 x 6		120	40 m/s	19000 rpm	10	12946	7.94 AUD	9																
40 x 20 x 6		240	40 m/s	19000 rpm	10	12949	7.98 AUD	9																
50 x 15 x 6		60	40 m/s	15200 rpm	10	12979	8.31 AUD	9																
50 x 15 x 6		80	40 m/s	15200 rpm	10	12980	8.31 AUD	9																
50 x 15 x 6		120	40 m/s	15200 rpm	10	12982	8.35 AUD	9																
50 x 20 x 6		40	40 m/s	15200 rpm	10	12996	8.97 AUD	9																
50 x 20 x 6		60	40 m/s	15200 rpm	10	12997	8.97 AUD	9																
50 x 20 x 6		80	40 m/s	15200 rpm	10	12998	8.97 AUD	9																

Other grits and sizes available on request.

Continuation →

Small abrasive mop

Abrasive mop



→ Continuation of KM 613, Small abrasive mop

Diameter x Width x Shaft in mm	Grit	Max. operating speed	Max. RPM	Packing unit/pcs.	Cat. number	Price/piece AUD	Discount group
50 x 20 x 6	120	40 m/s	15200 rpm	10	13000	9.00 AUD	9
50 x 30 x 6	40	40 m/s	15200 rpm	10	61282	10.03 AUD	9
50 x 30 x 6	60	40 m/s	15200 rpm	10	61299	10.03 AUD	9
50 x 30 x 6	80	40 m/s	15200 rpm	10	61319	10.03 AUD	9
50 x 30 x 6	120	40 m/s	15200 rpm	10	61350	10.09 AUD	9
60 x 20 x 6	40	40 m/s	12700 rpm	10	13032	9.89 AUD	9
60 x 20 x 6	60	40 m/s	12700 rpm	10	13033	9.89 AUD	9
60 x 20 x 6	80	40 m/s	12700 rpm	10	13034	9.89 AUD	9
60 x 20 x 6	120	40 m/s	12700 rpm	10	13036	9.91 AUD	9
60 x 30 x 6	40	40 m/s	12700 rpm	10	13050	10.53 AUD	9
60 x 30 x 6	60	40 m/s	12700 rpm	10	13051	10.53 AUD	9
60 x 30 x 6	80	40 m/s	12700 rpm	10	13052	10.53 AUD	9
60 x 30 x 6	120	40 m/s	12700 rpm	10	13054	10.61 AUD	9
60 x 40 x 6	40	40 m/s	12700 rpm	10	13068	13.01 AUD	9
60 x 40 x 6	60	40 m/s	12700 rpm	10	13069	13.01 AUD	9
60 x 40 x 6	80	40 m/s	12700 rpm	10	13070	13.01 AUD	9
60 x 40 x 6	120	40 m/s	12700 rpm	10	13072	13.07 AUD	9
60 x 50 x 6	40	32 m/s	10150 rpm	10	13086	14.89 AUD	9
60 x 50 x 6	60	32 m/s	10150 rpm	10	13087	14.89 AUD	9
60 x 50 x 6	80	32 m/s	10150 rpm	10	13088	14.89 AUD	9
80 x 20 x 6	60	40 m/s	9500 rpm	10	13123	11.94 AUD	9
80 x 30 x 6	40	40 m/s	9500 rpm	10	13140	15.21 AUD	9
80 x 30 x 6	60	40 m/s	9500 rpm	10	13141	15.21 AUD	9
80 x 30 x 6	80	40 m/s	9500 rpm	10	13142	15.21 AUD	9
80 x 30 x 6	120	40 m/s	9500 rpm	10	13144	15.32 AUD	9
80 x 50 x 6	40	32 m/s	7650 rpm	10	13176	21.14 AUD	9
80 x 50 x 6	60	32 m/s	7650 rpm	10	13177	21.14 AUD	9
80 x 50 x 6	80	32 m/s	7650 rpm	10	13178	21.14 AUD	9
80 x 50 x 6	120	32 m/s	7650 rpm	10	13180	21.23 AUD	9

Small finishing mop

NCS 600

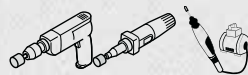

Properties

Bonding agent Resin
Grain Aluminium oxide

Applications:

Stainless steel	●
Metals	●
Plastic	○

Advantages: High removal rate and fine surface scratch pattern due to combination of non-woven and abrasive cloth flaps - Long service life

Diameter x Width x Shaft in mm	Grit	Grade	Colour	Max. operating speed	Max. RPM	Packing unit/pcs.	Cat. number	Price/piece AUD	Discount group
50 x 30 x 6	60	coarse	maroon	32 m/s	12200 rpm	10	258932	17.78 AUD	9
50 x 30 x 6	100	medium	maroon	32 m/s	12200 rpm	10	258933	17.78 AUD	9
60 x 30 x 6	60	coarse	maroon	32 m/s	10200 rpm	10	258936	21.74 AUD	9
60 x 30 x 6	100	medium	maroon	32 m/s	10200 rpm	10	258937	21.74 AUD	9
80 x 50 x 6	60	coarse	maroon	32 m/s	7600 rpm	10	258944	32.53 AUD	9
80 x 50 x 6	100	medium	maroon	32 m/s	7600 rpm	10	258945	32.53 AUD	9

Other grits and sizes available on request.



Abrasive flap discs

About the product

Since their market launch, the Klingspor abrasive flap disc has successfully taken the place of the grinding disc in many areas of surface finishing.























The performance of the abrasive flap disc, with its fan-shaped radial arrangement of cloth grinding flaps, far exceeds that of other abrasive products.

Klingspor abrasive flap discs are made of zirconia alumina, ceramic, or aluminium oxide coated flaps fastened to glass fibre-reinforced or plastic backing plates.

The even arrangement of the flaps guarantees high flexibility, constant high grinding performance and low vibrations.

Minimum order quantities for made to order items

Diameter	Minimum order quantities
up to 150 mm	320 pieces
180 mm	160 pieces

Type		Material								Application					
		Steel	Stainless steel	High alloy stainless steel	NF-metals	Aluminium	Wood	Plastics	Paint, varnishes, filler	Finish grinding	Welded seam work	Edge work; bevelling	Concave fillet weld work	Rust and varnish removal	Heat tinting and oxide film removal
SMT 314 EXTRA		●			●	●	○				●	●			
SMT 324 EXTRA		●	●	●						●					
SMT 324 EXTRA		●	●	●							●	●			
SMT 325 EXTRA		●	●	●						●					
SMT 325 EXTRA		●	●	●							●	●			
SMT 524 ACCU		●	●	●							●	●			
SMT 624 SUPRA		●	●	●							●	●			
SMT 626 SUPRA		●	●	●							●	●			
SMT 628 SUPRA		●	●	●						●					
SMT 636 SUPRA			●	●	●	●				●					
SMT 636 SUPRA			●	●	●	●					●	●			
SMT 644 SUPRA		●	●	●						●					
SMT 644 SUPRA		●	●	●							●	●			
SMT 645 SUPRA		●	●	●						●					
SMT 688 SPECIAL		●	●	●						●		●			
SMT 800 SPECIAL			●	●						●			●	●	
SMT 850 plus SPECIAL			●	●							●				
SMT 924 SPECIAL		●	●								●	●			
SMT 925 SPECIAL		●	●	●						●					
SMT 925 SPECIAL		●	●	●							●	●			
SMT 926 SPECIAL		●	●	●							●	●			
SMT 996 SPECIAL			●	●						●					
SMT 996 SPECIAL			●	●							●	●			
MFW 600		●	●	●								●			
NCD 200		●	○	●	●	●	●	●						●	●
PW 2000		●	●	●	●	●	●	●						●	●
NUD 500			●	●						●					●

● = main application ○ = possible application

Abrasive flap discs

Applications guide

1. Red bar

Label indicates the max. peripheral speed of 80 m/s

2. Safety recommendations

oSa label

3. Dimensions

Product dimensions in millimetre and inch

4. Punch ring

Manufacturer information, no expiry date!

5. Grit size

6. Cat. number

7. Safety recommendations

Language neutral pictograms

8. Quality class

Extra/Supra/Special

9. Product name

Type



Product groups

Klingspor offers three integrated product groups. For each user and application we offer the right abrasive flap disc. All abrasive flap discs are manufactured according to the applicable standards and guarantee the highest degree of safety.



EXTRA

Ideal price-performance ratio for universal implementation. Excellent grinding results on different steel materials.



SUPRA

Professional products with excellent service life and high stock removal rate. Aggressive grinding and long service life.



SPECIAL

High performance products for special industrial and trade applications. High performance and service life even when used intensively.

Abrasive flap discs

Applications guide



Product structure

The three abrasive flap disc components are perfectly integrated to achieve maximum performance.

1. Grinding flaps

Klingspor has developed special coated abrasives for its abrasive flap discs. The grinding tool is perfect for use with high speed angle grinders (80 m/s) and corresponding applications. This ensures top grinding performance and long service life.

2. Backing plate

Klingspor uses two different backing plate types to produce abrasive flap discs. The first one is the most popular on the market made of glass fibre; the second one is made of plastic.

3. Glue

The glue (adhesive) is the joint between the backing plate and the grinding flaps. It ensures that the grinding flaps cannot come off the backing plate if used properly. It also ensures safety far above the guidelines of the oSa directives and the EN 13743 safety standard.

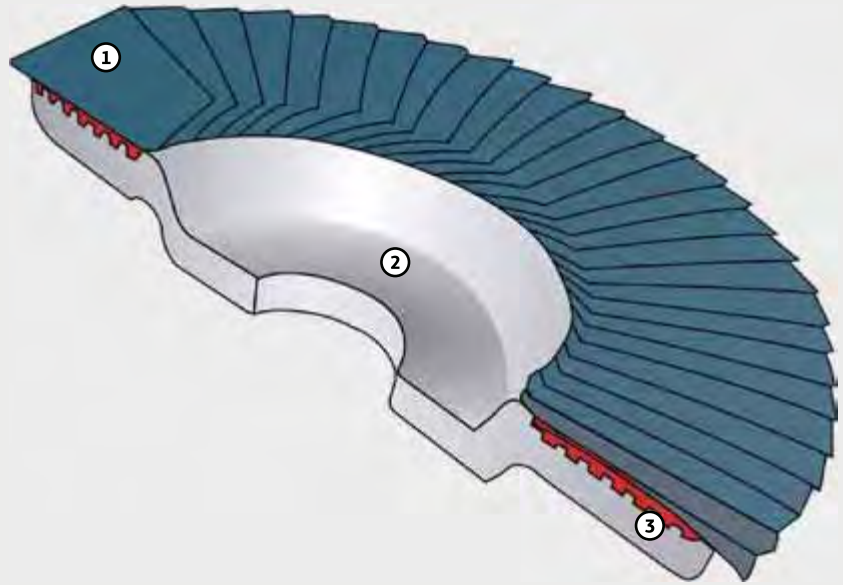

Form

The convex abrasive flap disc grinds a narrower surface than the flat abrasive flap disc. The more selective use of the convex disc achieves a greater stock removal rate per time unit as compared to the flat flap disc. The convex abrasive flap disc is particularly suited to working on edges and welded seams. The flat disc is primarily used for flat and surface grinding.

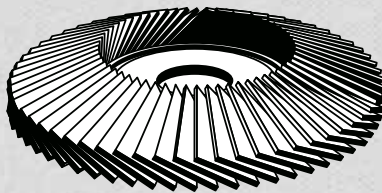

convex

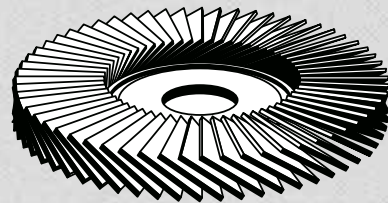

flat

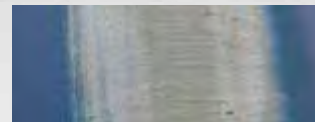

Abrasive flap discs

Applications guide

Coated abrasives

Compared to belt applications the coated abrasives for abrasive flap discs withstand much higher loads. On the one hand, the cutting speed of abrasive flap discs is approximately 2 to 2.5 times faster than the cutting rate of a belt application, on the other hand the backing must wear down to ensure that new, unused grit is used. Klingspor has developed special coated abrasives specifically for this product group. These are developed specifically for high powered angle grinders (80 m/s) and ensures top grinding performance and long service life (see diagram).

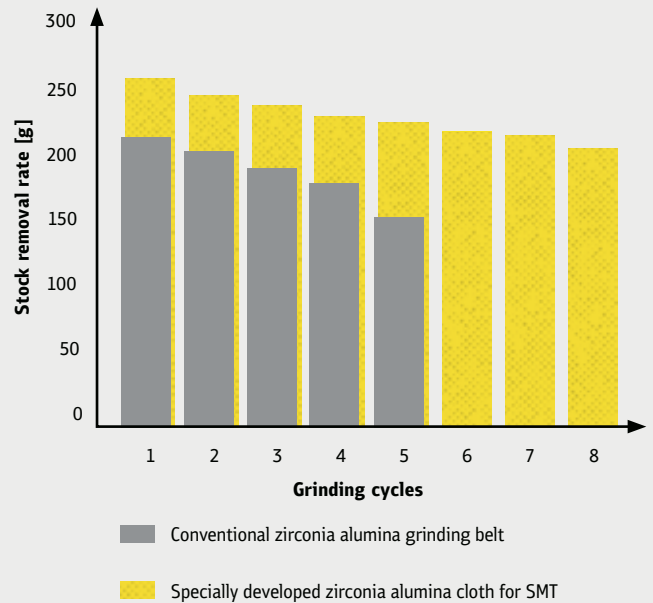

1. Zirconia alumina cloth

Zirconia alumina grit, heavy cotton polyester cloth, best performance with high power machines

2. Zirconia alumina cloth

Aggressive zirconia alumina grit, cotton cloth, good stock removal with angle grinders of all performance classes

3. Zirconia alumina + Multibond

Self-sharpening zirconia alumina grit, cotton backing, especially for cool grinding on stainless steel

4. Aluminium oxide cloth

Durable grit aluminium oxide, cotton cloth, for use with metal and NF-metals

5. Ceramic aluminium oxide + Multibond

Ceramic high performance grit, robust polyester backing high performance for stainless steel work, cool grinding on stainless steel surfaces

6. Ceramic aluminium oxide

Ceramic high performance grit, robust polyester backing, high performance for steel work



The safe use of Klingspor abrasives

Klingspor abrasive flap discs are manufactured according to the oSa and EN13743 standards, this ensures the highest level of user safety.



Wear safety goggles or glasses to protect the eyes



Wear safety gloves to protect hands



Wear a dust mask



Observe safety instructions



Use ear muffs



Do not use for wet grinding



Correctly mounted







Incorrectly mounted

Abrasive flap discs

SMT programme



		Steel / NF-metals	Steel / INOX		Service life	Stainless Steel	
		Aggression	Aggression			Aggression	
SPECIAL	Type:		SMT 924		SMT 925	SMT 926	SMT 996
							
	Aggression:		■■■■■■■		■■■■■■■	■■■■■■■□	■■■■■■■
	Service life:		■■■■■■■		■■■■■■■□	■■■■■■■	■■■■■■■□
	Backing plate:		Glass fibre		Plastic	Glass fibre	Glass fibre
Form:		convex (6°)		convex (12°) / flat	convex (6°)	convex (6°) / flat	
SUPRA	Type:		SMT 644				
							
	Aggression:		■■■■■■■□				
	Service life:		■■■■■■■□				
	Backing plate:		Glass fibre				
Form:		convex (12°) / flat					
EXTRA	Type:		SMT 624	SMT 628		SMT 626	SMT 636
							
	Aggression:		■■■■■■■□	■■■■■■■□		■■■■■■■□	■■■■■■■□
	Service life:		■■■■■■■□□	■■■■■■■□□		■■■■■■■□	■■■■■■■□□
	Backing plate:		Glass fibre	Glass fibre		Glass fibre	Glass fibre
Form:		convex (12°)	flat		convex (6°)	convex (6°) / flat	
EXTRA	Type:	SMT 314	SMT 324		SMT 325		
							
	Aggression:	■■■■■□□□	■■■■■□□□		■■■■■□□□		
	Service life:	■■■■■□□□	■■■■■□□□		■■■■■□□□		
	Backing plate:	Glass fibre	Glass fibre		Plastic		
Form:	convex (12°)	convex (12°) / flat		convex (12°) / flat			

Abrasive flap discs

Abrasive flap disc

SMT 624 SUPRA



Class	SUPRA
Aggression	■■■■■■■□
Service life	■■■■■■■□

Applications:	
Stainless steel	●
Steel	●



Properties	
Grain	Zirconia alumina
Backing plate	Glass fibre
Design	Convex 12°

Advantages: Aggressive stock removal rate and comfortable grinding behaviour - For universal use in demanding grinding work on steel and stainless steel - Optimal removal rate when used on high power angle grinders

Available grits:

16	24	30	36	40	50	60	80	100	120	150	180	220	240	280	320	360	400	500	600	800	1000	1200	1500	2000
Diameter x Bore in mm	Form	Grit	Max. operating speed	Max. RPM	Packing unit/pcs.	Cat. number	Price/piece AUD	Discount group																
100 x 16		36	80 m/s	15300 rpm	10	322758	10.27 AUD	10																
100 x 16		40	80 m/s	15300 rpm	10	322759	10.27 AUD	10																
100 x 16		60	80 m/s	15300 rpm	10	322760	10.27 AUD	10																
100 x 16		80	80 m/s	15300 rpm	10	322761	10.27 AUD	10																
100 x 16		120	80 m/s	15300 rpm	10	322762	10.27 AUD	10																
115 x 22,23		36	80 m/s	13300 rpm	10	322764	10.69 AUD	10																
115 x 22,23		40	80 m/s	13300 rpm	10	322765	10.69 AUD	10																
115 x 22,23		60	80 m/s	13300 rpm	10	322767	10.69 AUD	10																
115 x 22,23		80	80 m/s	13300 rpm	10	322768	10.69 AUD	10																
115 x 22,23		120	80 m/s	13300 rpm	10	322769	10.69 AUD	10																
125 x 22,23		36	80 m/s	12200 rpm	10	322771	12.62 AUD	10																
125 x 22,23		40	80 m/s	12200 rpm	10	322772	12.62 AUD	10																
125 x 22,23		60	80 m/s	12200 rpm	10	322774	12.62 AUD	10																
125 x 22,23		80	80 m/s	12200 rpm	10	322775	12.62 AUD	10																
125 x 22,23		120	80 m/s	12200 rpm	10	322776	12.62 AUD	10																
180 x 22,23		36	80 m/s	8500 rpm	10	322782	24.60 AUD	10																
180 x 22,23		40	80 m/s	8500 rpm	10	322783	24.60 AUD	10																
180 x 22,23		60	80 m/s	8500 rpm	10	322785	24.60 AUD	10																
180 x 22,23		80	80 m/s	8500 rpm	10	322786	24.60 AUD	10																
180 x 22,23		120	80 m/s	8500 rpm	10	322787	24.60 AUD	10																

Abrasive flap disc

SMT 626 SUPRA



Class	SUPRA
Aggression	■■■■■■■□
Service life	■■■■■■■□













Applications:	
Stainless steel	●
Steel	●



Properties	
Grain	Zirconia alumina
Backing plate	Glass fibre
Design	Convex 6°

Advantages: High material removal rates - Considerably longer service life due to unique flap angle

Available grits:

16 24 30 36 40 50 60 80 100 120 150 180 220 240 280 320 360 400 500 600 800 1000 1200 1500 2000																					
Diameter x Bore in mm	Form	Grit	Max. operating speed	Max. RPM	Packing unit/pcs.	Cat. number	Price/piece AUD	Discount group													
100 x 16		40	80 m/s	15300 rpm	10	321700	11.89 AUD	10													
100 x 16		60	80 m/s	15300 rpm	10	321681	11.89 AUD	10													
100 x 16		80	80 m/s	15300 rpm	10	321682	11.89 AUD	10													
100 x 16		120	80 m/s	15300 rpm	10	323536	11.89 AUD	10													
115 x 22,23		40	80 m/s	13300 rpm	10	321689	12.39 AUD	10													
115 x 22,23		60	80 m/s	13300 rpm	10	321694	12.39 AUD	10													
115 x 22,23		80	80 m/s	13300 rpm	10	321697	12.39 AUD	10													
115 x 22,23		120	80 m/s	13300 rpm	10	321683	12.39 AUD	10													
125 x 22,23		40	80 m/s	12200 rpm	10	321690	14.62 AUD	10													
125 x 22,23		60	80 m/s	12200 rpm	10	321695	14.62 AUD	10													
125 x 22,23		80	80 m/s	12200 rpm	10	321698	14.62 AUD	10													
125 x 22,23		120	80 m/s	12200 rpm	10	321684	14.62 AUD	10													

Abrasive flap discs

Abrasive flap disc

SMT 924 SPECIAL



Class	SPECIAL
Aggression	■■■■■■■■■
Service life	■■■■■■■■■

Applications:	
Stainless steel	●
Steel	●



Properties	
Grain	Ceramic Al. oxide
Backing plate	Glass fibre
Design	Convex 6°

Advantages: Highly aggressive abrasive performance for demanding work on edges - High edge stability - Optimal removal rate when used on high power angle grinders under increased grinding pressure

Available grits:

16	24	30	36	40	50	60	80	100	120	150	180	220	240	280	320	360	400	500	600	800	1000	1200	1500	2000
Diameter x Bore in mm	Form	Grit	Max. operating speed	Max. RPM	Packing unit/pcs.	Cat. number	Price/piece AUD	Discount group																
125 x 22,23		40	80 m/s	12200 rpm	10	322867	21.53 AUD	10																
125 x 22,23		60	80 m/s	12200 rpm	10	322868	21.53 AUD	10																
125 x 22,23		80	80 m/s	12200 rpm	10	322869	21.53 AUD	10																

Abrasive flap disc

SMT 926 SPECIAL



Class	SPECIAL
Aggression	■■■■■■■■□
Service life	■■■■■■■■■

Applications:	
Stainless steel	●
Steel	●



Properties	
Grain	Zirconia alumina
Backing plate	Glass fibre
Design	Convex 6°

Advantages: Maximum removal rate and service life - Especially suitable for rough work on steel and stainless steel - Optimal removal rate when used on high power angle grinders under increased grinding pressure

Available grits:

16	24	30	36	40	50	60	80	100	120	150	180	220	240	280	320	360	400	500	600	800	1000	1200	1500	2000
Diameter x Bore in mm	Form	Grit	Max. operating speed	Max. RPM	Packing unit/pcs.	Cat. number	Price/piece AUD	Discount group																
125 x 22,23		40	80 m/s	12200 rpm	10	321704	18.28 AUD	10																
125 x 22,23		60	80 m/s	12200 rpm	10	321707	18.28 AUD	10																
125 x 22,23		80	80 m/s	12200 rpm	10	321709	18.28 AUD	10																

Non-woven flap disc

SMT 800 SPECIAL



Class SPECIAL





Applications:

Stainless steel	●
Steel	●

Properties

Backing plate	Glass fibre
Design	Convex 12°

Advantages: High quality non-woven flap disc for stainless steel finish work - Optimal results when used on variable speed angle grinders - Three grades

Diameter x Bore in mm	Form	Grade	Colour	Max. operating speed	Max. RPM	Recommended operating speed	Recommended RPM	Packing unit/pcs.	Cat. number	Price/piece AUD	Discount group
125 x 22,23		coarse	brown	80 m/s	12200 rpm	42 m/s	6400 rpm	5	278498	30.64 AUD	10
125 x 22,23		medium	maroon	80 m/s	12200 rpm	42 m/s	6400 rpm	5	278499	30.64 AUD	10
125 x 22,23		very fine	green	80 m/s	12200 rpm	42 m/s	6400 rpm	5	278500	30.64 AUD	10

Combi-Abrasive flap disc

SMT 850 plus SPECIAL



Class SPECIAL





Applications:

Stainless steel	●
-----------------	---

Properties

Backing plate	Glass fibre
Design	Convex 12°

Advantages: High-quality combi non-woven flap disc - Specially suited for machining of WIG weld seams on stainless steel components - Even finish throughout the entire service life - Stock removal and finishing in one step

Diameter x Bore in mm	Form	Grit	Grade	Colour	Max. operating speed	Max. RPM	Recommended operating speed	Recommended RPM	Packing unit/pcs.	Cat. number	Price/piece AUD	Discount group
125 x 22,23		60	coarse	brown	80 m/s	12200 rpm	42 m/s	6400 rpm	5	312559	42.00 AUD	10
125 x 22,23		80	medium	maroon	80 m/s	12200 rpm	42 m/s	6400 rpm	5	312560	42.00 AUD	10
125 x 22,23		120	very fine	green	80 m/s	12200 rpm	42 m/s	6400 rpm	5	312561	42.00 AUD	10

High performance non-woven web wheels

High performance non-woven web wheels

MFW 600

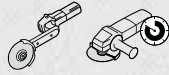

Applications:

Steel	●
Stainless steel	●
NF metals	●

Properties

Bonding agent	Resin
Grain	SiC

Advantages: Special product for finishing stainless steel weld seams - 4 different grades for material removal up to high gloss

Diameter x Width x Bore in mm	Grade	Colour	Max. operating speed	Max. RPM	Packing unit/pcs.	Cat. number	Price/piece AUD	Discount group
150 x 6 x 25,4	coarse	red	59 m/s	7500 rpm	5	337944	91.84 AUD	9
150 x 6 x 25,4	medium	grey	59 m/s	7500 rpm	5	337945	87.19 AUD	9
150 x 6 x 25,4	fine	grey	39 m/s	5000 rpm	5	337946	82.44 AUD	9

High performance non-woven web wheels

NUD 500



Applications:

Alloyed steels	●
High alloy steel	●
Non-ferrous metals	●
Light metals	●
Chrome and nickel steels	●
Steel	●
Titanium	●

Properties

Grain	SiC
-------	-----

Advantages: For cleaning and pre-polishing surfaces - For smoothing weld seams - Fewer work steps - Precise cleaning, clearing and finishing of surfaces - Achieves an ultra-low scratch depth on the processed material

Diameter x Width x Bore in mm	Grade	Colour	Max. operating speed	Max. RPM	Recommended RPM	Packing unit/pcs.	Cat. number	Price/piece AUD	Discount group
125 x 13 x 22,23	coarse	grey	63 m/s	9600 rpm	5300 rpm	5	337861	99.32 AUD	9
125 x 13 x 22,23	medium	grey	63 m/s	9600 rpm	5300 rpm	5	337862	79.87 AUD	9
125 x 13 x 22,23	very fine	grey	63 m/s	9600 rpm	5300 rpm	5	337863	69.24 AUD	9

Cleaning wheel

NCD 200







Applications:

Metals	●
Paint/Varnish/Filler	●
Plastic	●
Stainless steel	⓪

Properties

Bonding agent Resin	
Grain	SiC
Design	Flat

Advantages: Special SiC non-woven web for cleaning of surfaces and removal of heat tinting/blueing - No clogging due to open structure - For the removal of paint and rust

Diameter x Bore in mm	Form	Max. operating speed	Max. RPM	Packing unit/pcs.	Cat. number	Price/piece AUD	Discount group
100 x 16		63 m/s	12000 rpm	5	318660	20.15 AUD	9
115 x 22,23		63 m/s	10450 rpm	5	259043	29.56 AUD	9
125 x 22,23		63 m/s	9600 rpm	5	259044	32.39 AUD	9
180 x 22,23		63 m/s	6650 rpm	5	318745	40.54 AUD	9





Kronenflex® cutting-off wheels and grinding discs

About the product

As the inventor of the high speed cutting-off wheel, it is only natural that we strive to continually develop and improve our Kronenflex® products.

Kronenflex® cutting-off wheels and grinding discs feature an optimal combination of bonding agent and grain type for high aggressiveness, outstanding service life and consistently high quality. They comply with the highest safety standards, including the oSa regulations and the European safety standard EN 12413.

As a result of continuous innovations and the development of special products for diverse requirements, our Kronenflex® products offer the optimal solution for all standard materials and applications.

Typical materials for these products

- ▶ Steel
- ▶ Stainless steel
- ▶ Construction steel
- ▶ NF-metals
- ▶ Cast materials
- ▶ Stone
- ▶ Plastics
- ▶ Mineral materials
- ▶ Pipes
- ▶ Flat irons
- ▶ Tins
- ▶ Solid materials

Typical applications for these products

- ▶ Bodywork
- ▶ Maintenance and repair work
- ▶ Locksmiths
- ▶ Steelwork
- ▶ Plant construction
- ▶ Container construction
- ▶ Upkeep
- ▶ Metal works
- ▶ Vehicle construction
- ▶ Foundries
- ▶ Shipyards

Kronenflex® cutting-off wheels

Kronenflex® cutting-off wheels	Page
0,8–1,0 mm	101-113
Small cutting-off wheels	114
1,6–1,9 mm	115
2,0–3,2 mm	116-119
Large cutting-off wheels	120-23

Kronenflex® grinding discs

Kronenflex® grinding discs	Page
Grinding discs	124-129

Kronenflex® cutting-off wheels and grinding discs

Application guides

1. EAN-Code (EAN-13)
2. Safety pictograms
3. Max. operating speed
4. Klingspor Cat. No.
5. Specification of design, grade and bond according to EN 12413
6. Dimensions in mm and inches
7. Applications (see colour coding system)



8. Information about the manufacturer
9. Operating restrictions
10. Safety standard (oSa / EN 12413)
11. Max. RPM
12. Safety pictograms
13. Product group / type
14. Klingspor brand Kronenflex®

Quality classes

Kronenflex® cutting-off wheels and grinding discs come in three performance classes with six colour codes for a quick overview of the most important material applications.



EXTRA

Products for universal application, offering a particularly attractive price-performance ratio.



SUPRA

Optimised products for different applications. Excellent service life and cutting performance.



SPECIAL

High performance products for special applications. Highest service life and cutting performance in the respective material application area.

Kronenflex® cutting-off wheels and grinding discs

Application guides



1. Label and cover sheet

The label includes all of the important information on the product, manufacturer and information on the proper use of the grinding tool

2. Mixture

The grit: Today all grit types are only produced synthetically. Only grit produced synthetically can ensure continuously high wear and cutting disc quality.

Resins and fillers: Additional, important components for cutting and grinding discs are resins, (in liquid and dry form), and fillers. These components are key in determining the disc properties, such as stability, stock removal rate, sheer strength and can be adjusted to meet the needs of the specific application .



3. Metal ring

Provides information on the expiry date of the disc.

4. Glass fibre

Glass fibre is a reinforcing layer to ensure stability and increases the safety of the cutting-off wheel. The number and strength of the glass fibre layers is dependent upon disc type and application.

The higher the potential lateral load on a cutting-off disc (it is greater during free cutting than during stationary cutting), the more glass fibre that the cutting disc must contain, or the contained glass fibre must be more stable. Particularly thin material is used for thin cutting discs, (0.8 mm to 1.0 mm), to ensure that a large grit ratio is achieved between the layers. Grinding discs are constructed with at least 3 glass fibre layers.

Klingspor cutting-off wheel and grinding disc colour coding system



Metal universal:
Grey

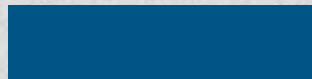

Stainless steel:
Blue



Aluminium:
Silver



Steel:
Black



Castings:
Red



Stone/concrete:
Green

Kronenflex® cutting-off wheels and grinding discs

Application guides



Safety and storage

The shelf life of cutting-off wheels and grinding discs is primarily determined by their moisture content. Cutting-off wheels and grinding discs that are subjected to increased humidity after they were manufactured lose their original service life. Correct storage ensures a consistent long service life. Cutting-off wheels and grinding discs that are subjected to water or steam are a safety risk. The user is obligated to use the product correctly.

Working safely...

... by being careful and recognising risks

Please avoid the risks listed below when working with cutting-off wheels and grinding discs.

- ▶ contact with rotating abrasive discs
- ▶ abrasive disc breakage
- ▶ grinding dust and debris
- ▶ vibration
- ▶ noise

... through personal protective gear

Goggles, gloves, ear muffs and dust masks must be worn. When working on hard grinding applications additional protective gear is required, such as face protection, leather aprons and safety boots.

... with protective machine guards

Machine guards are supplied with the grinding machine and may not be changed or removed. When using cup grinding wheels the outer surface must be completely enclosed.

In addition, cup grinding wheels may only be used in combination with an adjustable wheel guard, to balance the wear on the disc and to keep the exposure of the disc at a minimum.

... through visual inspection and performance of checks prior to mounting

Ensure the disc RPM matches the machine RPM setting and avoid exceeding the maximum admissible operating speed. Carefully check the cutting-off wheel and grinding disc for damage. If the cutting-off wheel or grinding disc is damaged, do not use the damaged product. Our cutting-off wheels and grinding discs are marked with the corresponding safety pictograms.

... through correct use

Ensure that the respective disc is being used correctly. Avoid damage to the mounting bore or to the disc through jerks, excessive force, or falls. Ensure that the disc is correctly and securely mounted and use the correct mounting flange. Prior to starting work, the abrasive disc should run at operating speed for at least 30 seconds. Please observe the FEPA safety regulations and the European Standard 12413.

The peripheral speed and grinding pressure are important parameters for achieving optimal cutting-off and grinding disc results.



The optimal speed

Too low

If the RPM of the machine is too low, the cutting-off wheel and grinding disc tend to “jump”, and the disc edges wear down unevenly. Particularly with thin material cross sections, such as cutting tin or wire, this causes the grit to be separated from the bond and the disc wear speed is above average.

Optimal

Klingspor cutting-off wheels and grinding discs are high performance products and were developed such that best disc performance (measured according the stock removal volume to disc wear ratio) is achieved in the range right below the maximum peripheral speed. Keep the machine running at a consistently high RPM and, if needed, select a more powerful machine.

Too high

The maximum RPM and peripheral speed is printed on the label of each disc. For your own safety, please be sure not to exceed the recommended speeds when grinding.

The correct grinding pressure

An important requirement for a satisfactory cutting result is the correct grinding pressure. A common mistake is to reduce the grinding pressure to preserve the disc and extend the cutting life of the wheel. If this is done, the material overheats (turns blue); the cutting-off wheel becomes clogged and “burns up”. This is why the grinding pressure should always be set such that the cutting time is as short as possible. This is particularly true for heat sensitive material with large material cross sections.

The proper hardness

...for cutting-off wheels

Generally, the rule of thumb when selecting the correct cutting-off wheel is: the harder the material, the softer the abrasive bond. The reason: the service life of a cutting-off wheel is dependent on whether the cutting surface of the workpiece hardens or not. Overheating results in the disc “glazing” and the cutting properties are negatively affected. In this case, the hardness of the bond should be decreased and a softer cutting-off wheel should be used.

...for grinding discs

The rule of thumb also applies to grinding discs: the harder the material, the softer the grinding disc bond. In addition, the application plays a decisive role. Corner grinding and the grinding of burrs and sharp edges can cause grit to be removed from the bond. We suggest the selection of a hard bond. On the other hand, when working on surfaces or small weld seams a disc that is too hard would become dull and would no longer be effective. It would have a good service life, but would also have a low stock removal rate and high work costs. A medium or soft disc bond would be best for finish grinding.

Kronenflex® cutting-off wheels and grinding discs

Application guides

Correct application/techniques for cutting-off

Pressure may only be placed on the cutting-off wheel from a radial direction. This is the only way to avoid wobbling, buckling and disc breakage, especially when applying a high level of cutting pressure. The workpiece that is to be cut-off should be properly affixed to the workbench to ensure that the disc does not slide off to the side. In addition, we recommend that the material is affixed as close to the cutting site as possible to ensure that it does not vibrate, flutter or slip to the side.

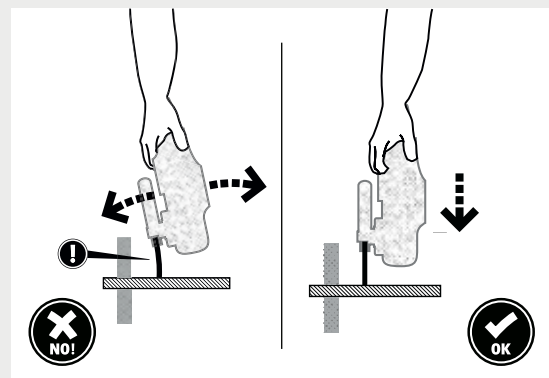
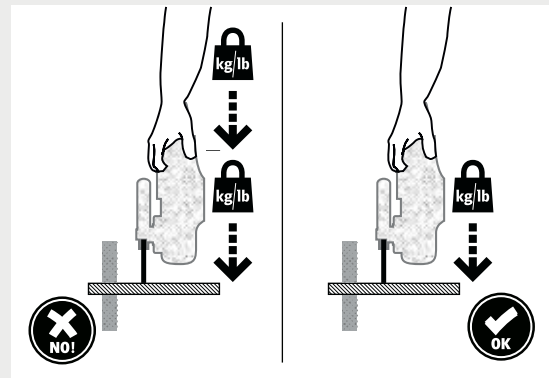

Correct application/techniques for grinding

Grinding discs work best at 35 degree angle to the workpiece. This angle provides the best stock removal to disc wear ratio. If possible, always select this angle. When grinding and the angle is below 15° a very thin edge which levels off is formed around the circumference of the disc. Even minimal changes to the angle can result in a situation in which the grinding pressure can no longer be absorbed resulting in the grinding disc slipping to the side. Valuable grit is not used and an imbalance is created that results in having to replace the disc prematurely.

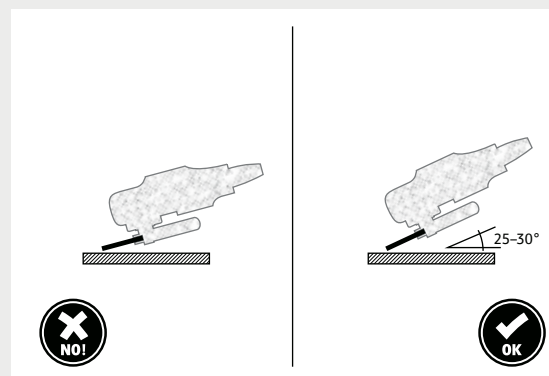
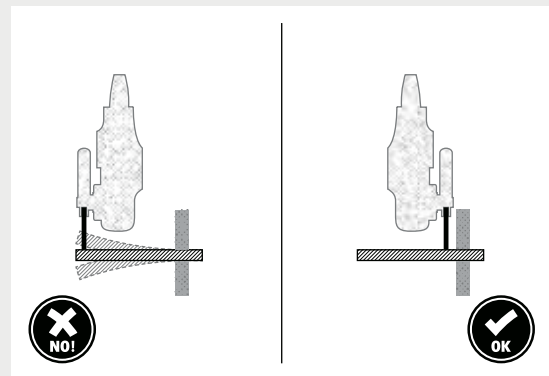

The correct mount

... for better power transmission

Cutting-off wheels and grinding discs are mounted to the machine with side flanges. The flange elements are responsible for transferring power to the disc. For reasons of safety it is extremely important that defective or incorrect flanges are not used.

... and for more safety

The use of wheel flange FL 76 provides increased lateral stability and user control, specifically when using thin cutting-off wheels with a flat form and diameter of 180 mm and 230 mm.

The applicable regulations and standards must be complied with when using the wheel flange. The contact surface and diameter of the wheel flange must match. Using wheel flanges with diameters that do not match is prohibited.

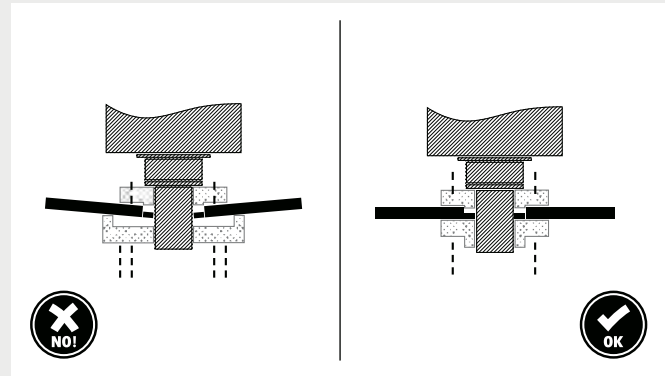

Depressed centre grinding discs

4 - 10 mm thickness

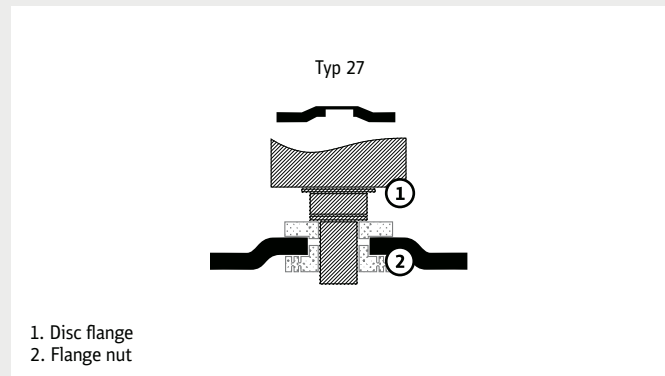

Flat and depressed centre cutting-off wheels

0.8 - 4 mm thickness

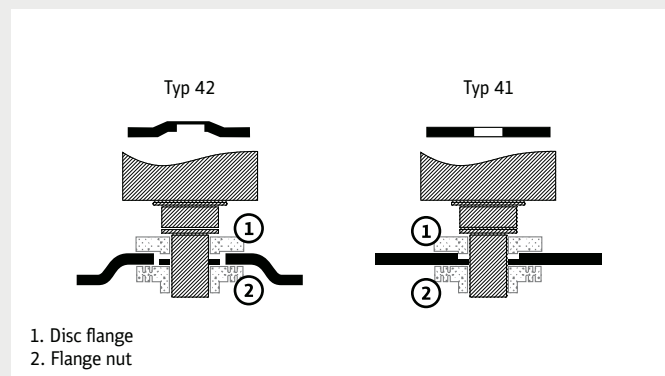

Kronenflex® cutting-off wheels and grinding discs

Application guides

Recognise and avoid errors

	Issue	Possible cause	Solution
Cutting-off discs	Cutting surface is blue	Cutting time is too long	Increase feed speed or grinding pressure
		Drive power is too low	Use a more powerful machine
		Disc is too hard	Select a softer bond
		Material cross section is too great for the disc diameter	Work with a saw cut / work with a smaller material diameter
		Cutting disc is too wide for the material/application	Use a thinner cutting disc
	Disc wear is too high	White cutting surface: disc hardness is too low	Select a harder bond
		Peripheral speed is too low	Increase peripheral speed
		RPM decrease is too great	Reduce grinding pressure or use a more powerful machine
	Crooked cut	Workpiece is not mounted properly	Mount the material closer to the cutting site
		Grinding pressure is too great	Reduce grinding pressure
		Disc width is too thin for the material/application	Increase disc width
		Disc is completely worn down	Replace disc
	Disc breakage	Machine is operated incorrectly	Avoid lateral pressure on the disc
		Incorrect wheel flange diameter	Use wheel flange with identical diameters
		Cutting-off wheel is used for grinding	Cutting-off wheels may not be used for grinding!
Disc periphery is frayed	Material is not properly affixed	Mount the material closer to the cutting site	
	Disc periphery is burned	Select a softer bond, decrease grinding pressure	
Disc jumps	Material is not properly affixed	Mount the material closer to the cutting site	
	Wheel flange is dirty or worn out	Clean wheel flange or replace wheel flange	
	Bearing is defective	Replace machine or replace bearing	
Bore hole is broken	Bore dimension and mount do not match	Use proper bore dimension or use a reducer ring	
	Wheel flanges are of different sizes	Use wheel flanges that have the same diameters	
	Machine is operated incorrectly	Reduce lateral pressure on the disc	
		Cutting-off wheel is used for grinding	Cutting-off wheels may not be used for grinding!

	Issue	Possible cause	Solution
Grinding discs	Removal rate is too low	Shiny contact surface: bond is too hard	Select a softer bond
		Grinding pressure is too low	Increase grinding pressure
		Machine performance is too low	Use a more powerful machine
	Disc is loaded/clogged	Bond is too hard	Select a softer bond
		Loading/clogging with NF metals	Use softer bond or select a special cutting-off wheel for NF metals
	Wear is too high	Grinding pressure is too low	Increase grinding pressure
		Grinding pressure is too high	Reduce grinding pressure
		Bond is too soft	Select a harder bond
		Machine RPM decreases too quickly	Reduce grinding pressure
		Machine performance is too low	Use a more powerful machine
	Periphery is not rounded / breakage on the edge	Disc angle is too flat	Increase disc angle (at least 25°)
		Grinding pressure is too high	Reduce grinding pressure
	Disc wobbles	The mount is not centred	Check bore diameter and mounting diameter and adjust accordingly
		Mounting shaft is worn	Replace machine
		Mounting flange is worn / dirty / incorrect	Replace / clean mounting flange / check dimensions
Disc wobbles		Use a new disc	

What the type designation reveals about the design of cutting-off wheels and grinding discs

The type designation given on a cutting-off wheel or grinding disc divulges more than just the name of the product. It provides important information on the performance class and on the composition of the tool. The first letter indicates which abrasive grit is used. If this letter is followed by a three digit number, the first digit signifies the performance class (the performance class is also included below the name of the product). The last two digits point to the size of the grit that was used. The letters at the end of the type designation mark the hardness grade of a cutting-off wheel or grinding disc.

Grit type	Performance class	Grit size according to FEPA standard	Hardness	Performance class
A Aluminium oxide	3 EXTRA	16	M soft	EXTRA
C Silicon carbide	6 SUPRA	24	N	SUPRA
Z Zirconia alumina	9 SPECIAL	30	R	SPECIAL
		36	S	
		46	T hard	
		60		
		80		

Explained by example of the Z 960 TX cutting-off wheel:

Grit type	Performance class	Grit size according to FEPA standard	Hardness	Performance class
Z Zirconia alumina	9 SPECIAL	60	TX hard	SPECIAL

The safe use of Klingspor abrasives

Klingspor Kronenflex cutting-off wheels and grinding discs are manufactured in accordance with the oSa and EN12413 standards, this ensures the highest level of user safety.



Wear safety goggles or glasses to protect the eyes



Wear safety gloves to protect hands



Wear dust mask



Observe safety instructions



Use ear muffs



Do not use for wet grinding



Not permitted for face grinding



Do not use if damaged

Kronenflex® cutting-off wheels 0,8 - 1,0 mm

for hand held machines

Cutting-off wheel INOX

A 980 TZ SPECIAL

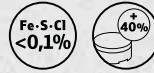

Class	SPECIAL
Bond	■■■■■■■□
Aggression	■■■■■■■□
Service life	■■■■■■■□

Applications:	
Stainless steel	●
Steel	●
NF metals	●

Advantages: Free of iron, sulfur and chlorine - Very short cutting times - Very precise and clean cuts - Low thermal load - Minimal burr formation, minimizing finish-machining - 25 pieces delivered in the Kronenflex® box for long-lasting high performance and moisture protection

Diameter x Width x Bore in mm	Form	Max. operating speed	Max. RPM	Packing unit/pcs.	Cat. number	Price/piece AUD	Discount group
125 x 0,8 x 22,23		80 m/s	12200 rpm	25	322183	3.37 AUD	11

Cutting-off wheel

A 60 N SUPRA



Class	SUPRA
Bond	■■■□□□□
Aggression	■■■■■■■□
Service life	■■■■■■■□

Applications:	
Aluminium	●
Steel	●

Advantages: Special combination prevents smearing and clogging - Minimal burr formation

Diameter x Width x Bore in mm	Form	Max. operating speed	Max. RPM	Packing unit/pcs.	Cat. number	Price/piece AUD	Discount group
115 x 1 x 22,23		80 m/s	13300 rpm	25	264297	3.00 AUD	11
125 x 1 x 22,23		80 m/s	12200 rpm	25	264298	3.31 AUD	11

Kronenflex® cutting-off wheels 0,8 - 1,0 mm for hand held machines



Cutting-off wheels

Cutting-off wheel

A 60 TZ SPECIAL



Class	SPECIAL		Applications:
Bond	■ ■ ■ ■ ■ ■ ■ □		Stainless steel ●
Aggression	■ ■ ■ ■ ■ □ □		Steel ●
Service life	■ ■ ■ ■ ■ □		NF metals ○

Advantages: Free of iron, sulfur and chlorine - Short cutting times - Minimal burr formation - Low thermal load

Diameter x Width x Bore in mm	Form	Max. operating speed	Max. RPM	Packing unit/pcs.	Cat. number	Price/piece AUD	Discount group
100 x 1 x 16	—	80 m/s	15300 rpm	25	202402	2.60 AUD	11
115 x 1 x 22,23	—	80 m/s	13300 rpm	25	202400	2.83 AUD	11
125 x 1 x 22,23	—	80 m/s	12200 rpm	25	202401	3.12 AUD	11

Cutting-off wheel

A 60 TZ SPECIAL



Class	SPECIAL		Applications:
Bond	■ ■ ■ ■ ■ ■ ■ □		Stainless steel ●
Aggression	■ ■ ■ ■ ■ □ □		Steel ●
Service life	■ ■ ■ ■ ■ □		NF metals ○

Advantages: Free of iron, sulphur and chlorine - Fast cutting - Minimal burr formation - Low thermal load - 10 pieces in a tin with viewing window

Diameter x Width x Bore in mm	Form	Max. operating speed	Max. RPM	Packing unit/tin	Cat. number	Price/tin AUD	Discount group
115 x 1 x 22,23	—	80 m/s	13300 rpm	10 discs	310503	30.35 AUD	11
125 x 1 x 22,23	—	80 m/s	12200 rpm	10 discs	310504	33.55 AUD	11

Minimum order quantity = 5 tins

Kronenflex® cutting-off wheels 0,8 - 1,0 mm

for hand held machines

Cutting-off wheel

A 60 TZ SPECIAL



Class	SPECIAL
Bond	■■■■■□□
Aggression	■■■■■□□
Service life	■■■■■□□

Applications:	
Stainless steel	●
Steel	●
NF metals	○

Advantages: Free of iron, sulfur and chlorine - Short cutting times - Minimal burr formation - Low thermal load

Diameter x Width x Bore in mm	Form	Max. operating speed	Max. RPM	Content of 1 selling unit	Content of 1 pack	Cat. number	Price/disc AUD	Price/pack AUD	Discount group
100 x 1 x 16	—	80 m/s	15300 rpm	10 wheels	5 selling units (50 wheels)	326295	2.80 AUD	140.00 AUD	11
115 x 1 x 22,23	—	80 m/s	13300 rpm	10 wheels	5 selling units (50 wheels)	326296	3.04 AUD	151.75 AUD	11
125 x 1 x 22,23	—	80 m/s	12200 rpm	10 wheels	5 selling units (50 wheels)	326297	3.36 AUD	167.75 AUD	11

1 pack (minimum order quantity) = 50 cutting-off wheels

Cutting-off wheel INOX

A 960 TZ SPECIAL



Class	SPECIAL
Bond	■■■■■
Aggression	■■■■■□
Service life	■■■■■

Applications:	
Stainless steel	●
Steel	●

Advantages: Free of iron, sulphur and chlorine - Short cutting times and long service life - Low thermal load - Low burr formation - Optimized bonding for considerably longer service life - For diverse applications - 25 pieces delivered in the Kronenflex® box for long lasting high performance and moisture protection

Diameter x Width x Bore in mm	Form	Max. operating speed	Max. RPM	Packing unit/pcs.	Cat. number	Price/piece AUD	Discount group
105 x 1 x 16	—	80 m/s	14500 rpm	25	326432	3.04 AUD	11
115 x 1 x 22,23	—	80 m/s	13300 rpm	25	322180	3.29 AUD	11
125 x 1 x 22,23	—	80 m/s	12200 rpm	25	322181	3.66 AUD	11

Kronenflex® cutting-off wheels 0,8 - 1,0 mm

for hand held machines



Cutting-off wheel INOX

Z 960 TX SPECIAL

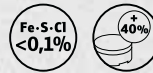

Class	SPECIAL
Bond	■ ■ ■ ■ ■ ■ ■ ■
Aggression	■ ■ ■ ■ ■ ■ ■ ■
Service life	■ ■ ■ ■ ■ ■ ■ ■

Applications:	
Stainless steel	●
Alloys	●
Carbon steel	●
Titanium	●

Advantages: Free of iron, sulphur and chlorine - Ideal for tough/hard materials such as titanium and high alloy steels - Short cutting times and long service life due to self-sharpening zirconia alumina - Low thermal load - Low burr formation - 25 pieces delivered in the Kronenflex® box for long lasting high performance and moisture protection

Diameter x Width x Bore in mm	Form	Max. operating speed	Max. RPM	Packing unit/pcs.	Cat. number	Price/piece AUD	Discount group
115 x 1 x 22,23	—	80 m/s	13300 rpm	25	322184	3.67 AUD	11
125 x 1 x 22,23	—	80 m/s	12200 rpm	25	322185	4.02 AUD	11

Kronenflex® small cutting-off wheel

for hand held machines

Small cutting-off wheel

A 660 R SUPRA

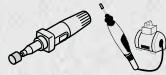

Class	SUPRA
Bond	■■■■■□□
Aggression	■■■■■□□
Service life	■■■■■□□

Applications:	
Steel	●
Stainless steel	●

Advantages: Minimal burr formation - For universal use in hard-to-reach areas - For cutting tins, profiles and solid materials

Diameter x Width x Bore in mm	Form	Max. operating speed	Max. RPM	Packing unit/pcs.	Cat. number	Price/piece AUD	Discount group
50 x 1 x 10	—	100 m/s	38200 rpm	100	329097	2.48 AUD	11
76 x 1 x 10	—	100 m/s	25200 rpm	100	329099	2.66 AUD	11

Fixing spindle

SD 660



Advantages: Fixing spindle for clamping on the small A 660 R cutting blades onto straight grinders, flexible shafts, and drilling machines - Fits 6 and 10 mm holes

Mounting in mm	Suitable for	Packing unit/pcs.	Cat. number	Price/piece AUD	Discount group
6	6 and 10 mm bore	1	337156	26.23 AUD	14

Kronenflex® cutting-off wheels 1,6 - 1,9 mm

for hand held machines



Cutting-off wheel INOX

A 46 TZ SPECIAL



**NEW
RECIPE**

Class	SPECIAL
Bond	■■■■■■■□
Aggression	■■■■■■■□
Service life	■■■■■■■□

Applications:	
Stainless steel	●

Advantages: Free of iron, sulphur and chlorine - Universal use on steel and stainless steel - First choice for professional applications and fast cutting of demanding materials

Diameter x Width x Bore in mm	Form	Max. operating speed	Max. RPM	Packing unit/pcs.	Cat. number	Price/piece AUD	Discount group
100 x 1,6 x 16	—	80 m/s	15300 rpm	25	194071	2.83 AUD	11
115 x 1,6 x 22,23	—	80 m/s	13300 rpm	25	187170	3.04 AUD	11
125 x 1,6 x 22,23	—	80 m/s	12200 rpm	25	187171	3.37 AUD	11
180 x 1,6 x 22,23	—	80 m/s	8500 rpm	25	221161	6.07 AUD	11
230 x 1,9 x 22,23	—	80 m/s	6600 rpm	25	224084	6.07 AUD	11

Kronenflex® cutting-off wheels 2,0 - 3,2 mm

for hand held machines

Cutting-off wheel

A 24 EXTRA



Class	EXTRA
Bond	■ ■ ■ ■ ■ □ □ □
Aggression	■ ■ ■ ■ □ □ □ □
Service life	■ ■ ■ ■ □ □ □ □

Applications:	
Metals	●

Advantages: Proven a million times over - Standard wheel with outstanding price-performance ratio - For universal use in metalworking - Fast cutting off of solid material

Diameter x Width x Bore in mm	Form	Max. operating speed	Max. RPM	Packing unit/pcs.	Cat. number	Price/piece AUD	Discount group
115 x 2,5 x 22,23		80 m/s	13300 rpm	25	242137	2.54 AUD	11
125 x 2,5 x 22,23		80 m/s	12200 rpm	25	328771	2.98 AUD	11
125 x 2,5 x 22,23		80 m/s	12200 rpm	25	328774	2.98 AUD	11
125 x 3,2 x 22,23		80 m/s	12200 rpm	25	209016	3.26 AUD	11
180 x 3 x 22,23		80 m/s	8500 rpm	25	328765	3.72 AUD	11
230 x 3 x 22,23		80 m/s	6600 rpm	25	328761	4.95 AUD	11
230 x 3 x 22,23		80 m/s	6600 rpm	25	328763	4.95 AUD	11

Cutting-off wheel

A 24 R SUPRA



Class	SUPRA
Bond	■ ■ ■ ■ ■ □ □ □
Aggression	■ ■ ■ ■ □ □ □ □
Service life	■ ■ ■ ■ □ □ □ □

Applications:	
Steel	●
Stainless steel	⦿
Castings	⦿

Advantages: Optimized combination for use on steel - Can be used on stainless steel - Good cutting properties

Diameter x Width x Bore in mm	Form	Max. operating speed	Max. RPM	Packing unit/pcs.	Cat. number	Price/piece AUD	Discount group
100 x 2,5 x 16		80 m/s	15300 rpm	25	70467	2.44 AUD	11
115 x 2,5 x 22,23		80 m/s	13300 rpm	25	328778	2.54 AUD	11
125 x 2,5 x 22,23		80 m/s	12200 rpm	25	328772	2.98 AUD	11
180 x 3 x 22,23		80 m/s	8500 rpm	25	328766	3.72 AUD	11
230 x 3 x 22,23		80 m/s	6600 rpm	25	328762	4.95 AUD	11

Kronenflex® cutting-off wheels 2,0 - 3,2 mm for hand held machines



Cutting-off wheels

Cutting-off wheel INOX

A 24 N SUPRA



Class	SUPRA	Applications:
Bond	■ ■ ■ ■ □ □ □ □	Stainless steel ●
Aggression	■ ■ ■ ■ ■ □ □ □	Aluminium ①
Service life	■ ■ ■ ■ ■ □ □ □	

Advantages: Special recipe prevents smearing and clogging - High removal rate on stainless steel due to hardened aluminium oxide

Diameter x Width x Bore in mm	Form	Max. operating speed	Max. RPM	Packing unit/pcs.	Cat. number	Price/piece AUD	Discount group
125 x 2,5 x 22,23		80 m/s	12200 rpm	25	2951	2.98 AUD	11
230 x 3 x 22,23		80 m/s	6600 rpm	25	13477	4.95 AUD	11

Cutting-off wheel INOX

A 36 R SUPRA



Class	SUPRA	Applications:
Bond	■ ■ ■ ■ □ □ □ □	Stainless steel ●
Aggression	■ ■ ■ ■ ■ □ □ □	
Service life	■ ■ ■ ■ ■ □ □ □	

Advantages: Excellent cutting performance - Optimized aggression and service life

Diameter x Width x Bore in mm	Form	Max. operating speed	Max. RPM	Packing unit/pcs.	Cat. number	Price/piece AUD	Discount group
115 x 2 x 22,23		80 m/s	13300 rpm	25	123208	2.80 AUD	11
125 x 2 x 22,23		80 m/s	12200 rpm	25	126849	3.13 AUD	11
180 x 2,5 x 22,23		80 m/s	8500 rpm	25	123209	4.54 AUD	11
230 x 2,5 x 22,23		80 m/s	6600 rpm	25	123833	6.04 AUD	11

Kronenflex® cutting-off wheels 2,0 - 3,2 mm

for hand held machines

Cutting-off wheel INOX

A 36 TZ SPECIAL



Class	SPECIAL
Bond	■ ■ ■ ■ ■ ■ ■ □
Aggression	■ ■ ■ ■ ■ ■ ■ ■
Service life	■ ■ ■ ■ ■ □ □

Applications:	
Stainless steel	●
Steel	○

Advantages: Very good cutting performance, even with low grinding pressure

Diameter x Width x Bore in mm	Form	Max. operating speed	Max. RPM	Packing unit/pcs.	Cat. number	Price/piece AUD	Discount group
230 x 2 x 22,23	—	80 m/s	6600 rpm	25	136552	8.00 AUD	11

Cutting-off wheel

A 46 N SUPRA



Class	SUPRA
Bond	■ ■ ■ □ □ □ □
Aggression	■ ■ ■ ■ ■ □ □
Service life	■ ■ ■ ■ ■ □ □

Applications:	
Aluminium	●

Advantages: Special combination prevents smearing and clogging - Optimized cutting off performance on non-ferrous metals

Diameter x Width x Bore in mm	Form	Max. operating speed	Max. RPM	Packing unit/pcs.	Cat. number	Price/piece AUD	Discount group
230 x 3 x 22,23	—	80 m/s	6600 rpm	25	170710	7.38 AUD	11

Kronenflex® cutting-off wheels 2,0 - 3,2 mm for hand held machines



Cutting-off wheel

C 24 EXTRA



Class	EXTRA
Bond	■ ■ ■ ■ □ □ □ □
Aggression	■ ■ ■ ■ □ □ □ □
Service life	■ ■ ■ ■ □ □ □ □

Applications:
Stone/Concrete ●

Advantages: Universal cutting-off wheel for all mineral materials - Wide application range due to sharp, coarse SiC grit

Diameter x Width x Bore in mm	Form	Max. operating speed	Max. RPM	Packing unit/pcs.	Cat. number	Price/piece AUD	Discount group
100 x 2,5 x 16		80 m/s	15300 rpm	25	188999	2.71 AUD	11
115 x 2,5 x 22,23		80 m/s	13300 rpm	25	242143	3.27 AUD	11
125 x 2,5 x 22,23		80 m/s	12200 rpm	25	242144	3.50 AUD	11
230 x 3 x 22,23		80 m/s	6600 rpm	25	13491	5.15 AUD	11

Kronenflex® large cutting-off wheels

for petrol driven saw / cutter

Cutting-off wheel

A 24 R SPECIAL



Class	SPECIAL
Bond	■ ■ ■ ■ ■ □ □
Aggression	■ ■ ■ ■ ■ □ □
Service life	■ ■ ■ ■ ■ □ □

Applications:	
Steel	●
Stainless steel	◐
Castings	◐

Advantages: Fast cutting, also of solid material - Optimised combination for use on steel - Can be also used on stainless steel - For use on gas powered freehand machines with a cutting speed of 80 m/s

Diameter x Width x Bore in mm	Form	Max. operating speed	Max. RPM	Packing unit/pcs.	Cat. number	Price/piece AUD	Discount group
300 x 3,5 x 20	—	80 m/s	5100 rpm	10	288245*	12.17 AUD	11
300 x 3,5 x 25,4	—	80 m/s	5100 rpm	10	288247	12.17 AUD	11
350 x 4 x 25,4	—	80 m/s	4400 rpm	10	288250	20.81 AUD	11

* May not be used on STIHL cut-off saw TS 410

Cutting-off wheel

C 24 RA SPECIAL



Class	SPECIAL
Bond	■ ■ ■ ■ ■ □ □
Aggression	■ ■ ■ ■ ■ □ □
Service life	■ ■ ■ ■ ■ □ □

Applications:	
Asphalt	●
Stone/Concrete	◐

Advantages: Special combination for asphalt - No clogging - Sharp, coarse SiC grain - For use on gas powered freehand machines with a cutting speed of 80 m/s

Diameter x Width x Bore in mm	Form	Max. operating speed	Max. RPM	Packing unit/pcs.	Cat. number	Price/piece AUD	Discount group
350 x 4 x 20	—	80 m/s	4400 rpm	10	288252**	20.29 AUD	11
350 x 4 x 25,4	—	80 m/s	4400 rpm	10	288253	20.29 AUD	11

** May not be used on STIHL cut-off saws TS 420 / TS 500i / TS 700

Kronenflex® large cutting-off wheels

for petrol powered cutter with clamping device



Cutting-off wheel

A 24 SW SPECIAL



Class	SPECIAL
Bond	■ ■ ■ ■ ■ ■ ■ □
Aggression	■ ■ ■ ■ ■ ■ ■ □
Service life	■ ■ ■ ■ ■ ■ ■ □

Applications:	
Steel	●

Advantages: Cutting-off wheel for railway rails - Aggressive cutting properties - For use on petrol driven cutting-off machines with a cutting speed of 100 m/s and clamping device - Maximum aggressiveness and service life

Diameter x Width x Bore in mm	Form	Max. operating speed	Max. RPM	Packing unit/pcs.	Cat. number	Price/piece AUD	Discount group
350 x 4 x 25,4	—	100 m/s	5500 rpm	10	254442	23.81 AUD	11
400 x 4 x 25,4	—	100 m/s	4800 rpm	10	254052	28.50 AUD	11

Kronenflex® large cutting-off wheels

for stationary cutting / chop saws

Cutting-off wheel

A 24 R SUPRA

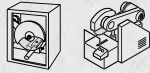

Class	SUPRA
Bond	■ ■ ■ ■ ■ □ □
Aggression	■ ■ ■ ■ □ □ □ □
Service life	■ ■ ■ ■ ■ □ □

Applications:	
Steel	●
Stainless steel	○
Castings	○

Advantages: Optimized combination for use on steel - Can be used on stainless steel - Good cutting properties - Optimal for stationary 3 - 5 kW cutting-off machine

Diameter x Width x Bore in mm	Form	Max. operating speed	Max. RPM	Packing unit/pcs.	Cat. number	Price/piece AUD	Discount group
300 x 3 x 25,4	—	100 m/s	6400 rpm	10	6793	12.90 AUD	11
350 x 3,5 x 25,4	—	100 m/s	5500 rpm	10	13528	20.84 AUD	11
400 x 4,5 x 25,4	—	100 m/s	4800 rpm	10	292933	31.26 AUD	11

Cutting-off wheel

A 630 N SUPRA



Class	SUPRA
Bond	■ ■ ■ ■ ■ □ □
Aggression	■ ■ ■ ■ ■ □ □ □
Service life	■ ■ ■ ■ ■ □ □

Applications:	
Steel	●
Stainless steel	○
Aluminium	○
Castings	○

Advantages: Aggressive model with an outstanding service life - An exceptional choice for 110 volt machines and the cutting of solid material - Bond optimized for universal use - Low thermal load - Minimum burr formation

Diameter x Width x Bore in mm	Form	Max. operating speed	Max. RPM	Packing unit/pcs.	Cat. number	Price/piece AUD	Discount group
350 x 2,5 x 25,4	—	80 m/s	4400 rpm	10	339070	9.81 AUD	11

Kronenflex® large cutting-off wheels

for chop saws



Cutting-off wheels

Cutting-off wheel

A 930 N SPECIAL



Class	SPECIAL	Applications:
Bond	■ ■ ■ ■ □ □ □ □	Steel ●
Aggression	■ ■ ■ ■ ■ ■ ■ □	Stainless steel ①
Service life	■ ■ ■ ■ □ □ □ □	Aluminium ①
		Castings ①

Advantages: For universal use on chop saws - Minimal burr formation - Can be used on table cutting-off machines < 3 kW

Diameter x Width x Bore in mm	Form	Max. operating speed	Max. RPM	Packing unit/pcs.	Cat. number	Price/piece AUD	Discount group
350 x 3 x 25,4		80 m/s	4400 rpm	10	322628	13.74 AUD	11

Cutting-off wheel

A 30 N SPECIAL



Class	SPECIAL	Applications:
Bond	■ ■ ■ □ □ □ □ □	Steel ●
Aggression	■ ■ ■ ■ ■ ■ ■ □	Stainless steel ①
Service life	■ ■ ■ ■ □ □ □ □	Aluminium ①
		Castings ①

Advantages: For universal use on chop saws - Minimal burr formation - Can be used on table cutting-off machines < 3 kW

Diameter x Width x Bore in mm	Form	Max. operating speed	Max. RPM	Packing unit/pcs.	Cat. number	Price/piece AUD	Discount group
300 x 2,5 x 25,4		80 m/s	5100 rpm	10	119627	12.18 AUD	11
350 x 3 x 25,4		80 m/s	4400 rpm	10	119628	13.07 AUD	11
400 x 3,5 x 25,4		80 m/s	3800 rpm	10	119629	20.14 AUD	11





Kronenflex® grinding discs

About the product

Kronenflex® grinding discs are characterised by their permanent high level of attack and maximum stock removal. The optimum relationship between performance and service life is guaranteed up to the complete use of the disc.

Kronenflex® grinding discs are used in all major surface grinding applications, as well as for edge bevelling and burr removal. Klingspor offers professional advice in selecting the right grinding disc for your application.

From general metalworking to material-related applications in steel, stainless steel and NF metals, to the more specialised requirements of the nuclear industry, Klingspor has the products you need. Discs for stone grinding and cup grinding wheels round off our programme.

Our engineers are standing by to help you, should you have specific problems or technical questions. You may take advantage of our technical consulting services whether at Klingspor or directly on site.

Practical tips

The rule of thumb also applies to grinding discs: the harder the material, the softer the bond of the grinding disc.

In addition, the application plays a very decisive role.

Corners and burrs have very sharp edges and easily tear the grit out of the bond. We recommend the use of a hard bond.

If on the other hand one is working on surfaces i.e. small welded seams, a disc that is too hard would easily become dull and no longer grip the material. The disc would achieve a good service life, but this would result in a low stock removal rate and high work costs.

For finish grinding the best disc bond is a medium or soft disc bond.

Grinding discs

Type	Thickness [mm]	Material applications												
		Steel	Hardened steels	Tool steel	Stainless steel	High alloy steels	Corrosion and acid proof steels	Aluminium	Bronze	Copper	Brass	Zinc die-casting	Cast iron	Stone / concrete
A 24 EXTRA	6,0–8,0	●	○	○	○	○	○					○	○	
A 24 EXTRA T	6,0–8,0	●	○	○	○	○	○						○	
A 24 R SUPRA	4,0–10	●	●	●	○	○	○						○	
A 24 R/01 SPECIAL	4,0	●	●	●	○	○	○							
A 24 N SUPRA INOX	6,0–8,0	○	●	○	●	●	●							
A 24 R/36 SPECIAL	6,0	○	○	○	●	●	●							
A 46 N SUPRA	6,0–8,0							●	○	○	○	○		
A 46 VZ SPECIAL	2,0	○	○	●	●	●	●					○		
A 546 ACCU	2,0	○	○	●	●	●	●					○		
A 624 T SUPRA	6,0	●	●	●	●	○	○					○	●	
A 24 TX SPECIAL	6	○	○	○	○	○	○						●	
C 24 R SUPRA	6												○	●
A 16 R SUPRA	55	●											○	
A 30 R SUPRA	55	●												
C 16 R SUPRA	55												○	●
C 30 R SUPRA	55												○	●

● = main application ○ = possible applications

Kronenflex® grinding discs

for hand held machines

Grinding disc

A 24 EXTRA



Class	EXTRA
Bond	■ ■ ■ ■ □ □ □ □
Aggression	■ ■ ■ ■ □ □ □ □
Service life	■ ■ ■ ■ □ □ □ □

Applications:	
Metals	●

Advantages: Standard disc with excellent price-performance ratio - For universal use in metalworking - Excellent results on all standard angle grinders

Diameter x Width x Bore in mm	Form	Max. operating speed	Max. RPM	Packing unit/pcs.	Cat. number	Price/piece AUD	Discount group
100 x 6 x 16		80 m/s	15300 rpm	10	328786	2.56 AUD	11
115 x 6 x 22,23		80 m/s	13300 rpm	10	328781	3.18 AUD	11
125 x 6 x 22,23		80 m/s	12200 rpm	10	328782	3.57 AUD	11
180 x 6 x 22,23		80 m/s	8500 rpm	10	328783	5.78 AUD	11
230 x 6 x 22,23		80 m/s	6600 rpm	10	13447	8.15 AUD	11

Grinding disc

A 24 R SUPRA



Class	SUPRA
Bond	■ ■ ■ ■ □ □ □ □
Aggression	■ ■ ■ ■ □ □ □ □
Service life	■ ■ ■ ■ □ □ □ □

Applications:	
Steel	●
Stainless steel	◐
Castings	◑

Advantages: With optimised recipe for use on steel - Also suitable for use on stainless steel - Large product range

Diameter x Width x Bore in mm	Form	Max. operating speed	Max. RPM	Packing unit/pcs.	Cat. number	Price/piece AUD	Discount group
100 x 4 x 16		80 m/s	15300 rpm	10	13400	2.56 AUD	11
100 x 6 x 16		80 m/s	15300 rpm	10	6578	2.56 AUD	11
115 x 6 x 22,23		80 m/s	13300 rpm	10	13401	3.18 AUD	11
125 x 4 x 22,23		80 m/s	12200 rpm	10	240831	3.57 AUD	11
125 x 6 x 22,23		80 m/s	12200 rpm	10	13402	3.57 AUD	11
180 x 7 x 22,23		80 m/s	8500 rpm	10	13413	6.40 AUD	11
230 x 6 x 22,23		80 m/s	6600 rpm	10	13433	8.15 AUD	11





Grinding disc INOX

A 24 N SUPRA



Class	SUPRA	Applications:
Bond	■ ■ ■ ■ □ □ □ □	Stainless steel ●
Aggression	■ ■ ■ ■ ■ □ □ □	Aluminium ○
Service life	■ ■ ■ ■ □ □ □ □	

Advantages: High removal rate on stainless steel - Optimal ratio between removal and wear

Diameter x Width x Bore in mm	Form	Max. operating speed	Max. RPM	Packing unit/pcs.	Cat. number	Price/piece AUD	Discount group
115 x 6 x 22,23		80 m/s	13300 rpm	10	2923	3.72 AUD	11
125 x 6 x 22,23		80 m/s	12200 rpm	10	2922	4.12 AUD	11
180 x 6 x 22,23		80 m/s	8500 rpm	10	13412	7.30 AUD	11
230 x 6 x 22,23		80 m/s	6600 rpm	10	13432	11.30 AUD	11

Grinding disc

A 24 R/36 SPECIAL



Class	SPECIAL	Applications:
Bond	■ ■ ■ ■ □ □ □ □	Stainless steel ●
Aggression	■ ■ ■ ■ ■ □ □ □	
Service life	■ ■ ■ ■ ■ □ □ □	

Advantages: Special wheel for the nuclear industry - Free of iron, sulfur and chlorine - Optimal ratio between removal and wear

Diameter x Width x Bore in mm	Form	Max. operating speed	Max. RPM	Packing unit/pcs.	Cat. number	Price/piece AUD	Discount group
125 x 6 x 22,23		80 m/s	12200 rpm	10	2830	4.12 AUD	11

Kronenflex® grinding discs

for hand held machines

Grinding disc

A 30 M SPECIAL



Class	SPECIAL
Bond	■ ■ ■ ■ □ □ □ □
Aggression	■ ■ ■ ■ □ □ □ □
Service life	■ ■ ■ ■ □ □ □ □

Applications:	
Stainless steel	●

Advantages: Special wheel for the nuclear industry - Optimal ratio between removal and wear

Diameter x Width x Bore in mm	Form	Max. operating speed	Max. RPM	Packing unit/pcs.	Cat. number	Price/piece AUD	Discount group
125 x 6 x 22,23		80 m/s	12200 rpm	10	310900	3.74 AUD	11

Grinding disc

A 46 N SUPRA



Class	SUPRA
Bond	■ ■ ■ □ □ □ □ □
Aggression	■ ■ ■ ■ □ □ □ □
Service life	■ ■ ■ ■ □ □ □ □

Applications:	
Aluminium	●
NF metals	ⓘ

Advantages: No clogging when used on non-ferrous metals - Optimal ratio between removal and wear

Diameter x Width x Bore in mm	Form	Max. operating speed	Max. RPM	Packing unit/pcs.	Cat. number	Price/piece AUD	Discount group
125 x 6 x 22,23		80 m/s	12200 rpm	10	2226	5.55 AUD	11
180 x 6 x 22,23		80 m/s	8500 rpm	10	13410	9.59 AUD	11

Thin cutting-off wheel & grinding disc

A 46 VZ SPECIAL



Class	SPECIAL	Applications:
Bond	■ ■ ■ ■ ■ ■ ■ □	Stainless steel ●
Aggression	■ ■ ■ ■ ■ ■ ■ □	Steel ●
Service life	■ ■ ■ ■ ■ ■ ■ □	NF metals ○

Advantages: Long service life - Multi-purpose: cutting off and light rough grinding with one wheel - High aggressiveness in cutting - No change of wheel necessary

Diameter x Width x Bore in mm	Form	Max. operating speed	Max. RPM	Packing unit/pcs.	Cat. number	Price/piece AUD	Discount group
125 x 2 x 22,23		80 m/s	12200 rpm	25	298177	4.97 AUD	11



Grinding disc

C 24 R SUPRA



Class	SUPRA	Applications:
Bond	■ ■ ■ □ □ □ □ □	Stone/Concrete ●
Aggression	■ ■ ■ □ □ □ □ □	Castings ○
Service life	■ ■ ■ □ □ □ □ □	

Advantages: Ideal for use on stone and mineral materials - High removal rate due to sharp, coarse SiC grain

Diameter x Width x Bore in mm	Form	Max. operating speed	Max. RPM	Packing unit/pcs.	Cat. number	Price/piece AUD	Discount group
115 x 6 x 22,23		80 m/s	13300 rpm	10	6664	3.18 AUD	11
125 x 6 x 22,23		80 m/s	12200 rpm	10	6665	3.57 AUD	11



Diamond tools



Remain in full control of all processes: staying true to this motto, Klingspor managed to rise to be one of the world's first manufacturers of grinding and cutting tools. The company is now applying their extensive experience in research and development and manufacturing, their global network of distributors and their highly efficient service and logistics structure to their diamond tools.

Product	Machine	Application - Material	SPECIAL	SUPRA	EXTRA	
Diamond cutting blades Ø 100 - 230 mm	Angle grinder	Universal	<i>DT 900 U</i>	<i>DT 600 U</i>	<i>DT 300 U</i>	
					<i>DT 350 U</i>	
			<i>DT 900 UD</i>		<i>DT 300 UT</i>	
			<i>DT 900 UT</i>		<i>DT 310 UT</i>	
		Concrete				<i>DT 500 AC</i>
			<i>DT 900 B</i>			
		Clinker				
		Lime sandstone, screed and abrasive materials			<i>DT 600 AS</i>	
		Granite				
			<i>DT 900 G</i>		<i>DT 600 G</i>	
			<i>DT 600 GU</i>			
Tiles						
	<i>DT 900 FL</i>		<i>DT 600 F</i>	<i>DT 300 F</i>		
	<i>DT 900 FT</i>					
		<i>DT 900 FP</i>				
Mortar rake			<i>DN 600 U</i>			
Cup grinding wheels	Angle grinder	Concrete		<i>DS 600 B</i>	<i>DS 300 B</i>	
				<i>DS 600 S</i>		
		Lime sandstone, screed and abrasive materials		<i>DS 600 A</i>		
		Granite			<i>DS 600 GC</i>	
			<i>DS 600 GM</i>		<i>DS 600 GF</i>	
Adapter M14				<i>DZ 114</i>		
Diamond cutting blades Ø 250 - 500 mm	Petrol powered cutter, Table saw, Joint cutter	Universal	<i>DT 900 U</i>	<i>DT 600 U</i>	<i>DT 300 U</i>	
			<i>DT 900 US</i>	<i>DT 612 UT</i>	<i>DT 310 UT</i>	
		Tiles				<i>DT 350 U</i>
			<i>DT 900 FL</i>	<i>DT 600 F</i>	<i>DT 300 F</i>	
		Clinker	<i>DT 900 K</i>			
		Refractory brick	<i>DT 900 R</i>			
		Asphalt	<i>DT 902 A</i>	<i>DT 602 A</i>	<i>DT 350 A</i>	
			<i>DT 910 A</i>	<i>DT 612 A</i>		
		Asphalt / concrete		<i>DT 612 AB</i>	<i>DT 350 AB</i>	
		Green concrete	<i>DT 910 BF</i>			
		Concrete			<i>DT 602 B</i>	
			<i>DT 900 B</i>			
<i>DT 902 B</i>						
	<i>DT 910 B</i>					
Reduction rings				<i>DZ 100 RR</i>		
Drill bits	Drill stand	Concrete	<i>DR 912 B</i>	<i>DK 612 B</i>		
				<i>DK 654 B</i>		
	Individual segments, ring segments		<i>DO 900 B</i>	<i>DE 600 B</i>		
	Percussion drill	Concrete		<i>DD 600 U</i>		
		Adapter kit			<i>ADS 200</i>	
	Drilling machine	Tiles		<i>DB 600 F</i>		
	Angle grinder	Tiles		<i>DK 600 F</i>		
Hole starting aid				<i>ABH 80</i>		

Diamond tools

Applications guide

The three product lines

The right tool for every application: Klingspor diamond tools are available in three product lines that are colour-coded to provide the user with a quick overview of the most important materials for which the tools are suitable.



SPECIAL

Product line 900 – High performance tools offering outstanding cutting performance and service life. For users who need their tools to perform at peak output and reliability even if subjected to the most punishing applications.



SUPRA

Product line 600 – Professional tools with an exceptional price-performance ratio. For users who require diamond tools that deliver reliable and powerful performance every day.



EXTRA

Product line 300 – Brand name quality at an affordable price. For users who expect their tools to meet professional standards, but do not need to use them continuously.

1. Klingspor Cat. No.
2. Product group / type
3. Applications
4. Safety pictograms
5. Max. operating speed
6. Klingspor logo

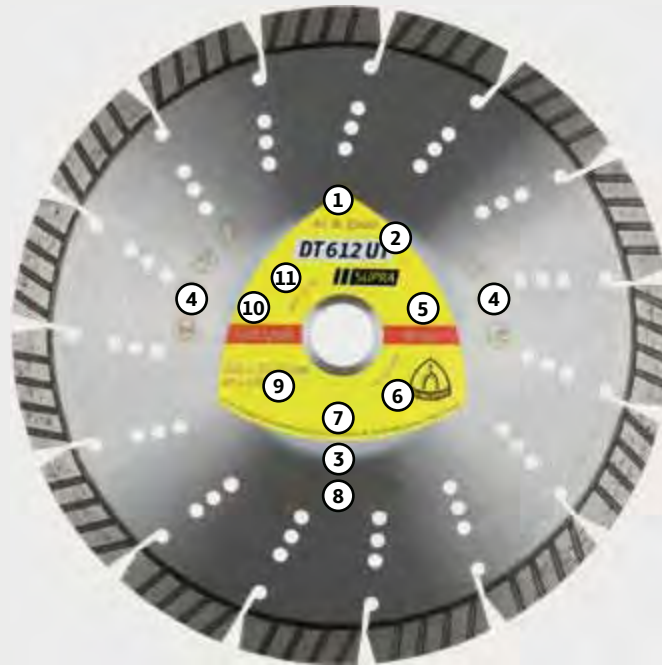

7. Information about the manufacturer
8. Safety standard
9. Dimensions in mm and inches
10. Max. RPM
11. Rotational direction

Colour-coding system of the Klingspor® diamond tools



Asphalt

Black



Tiles

Green

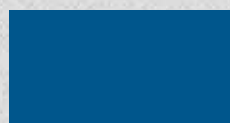

Stone/Fireproof

Blue



Concrete

Red

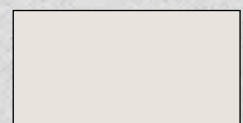

Universal

White

Diamond tools

Applications guide



1.

Standard gullet

- ▶ rapid feed rate
- ▶ exceptional cutting properties



2.

Turbo continuous rim

- ▶ exceptionally smooth operation
- ▶ clean cutting edges



3.

Continuous rim

- ▶ clean cutting edges
- ▶ work with superior precision
- ▶ short cutting times

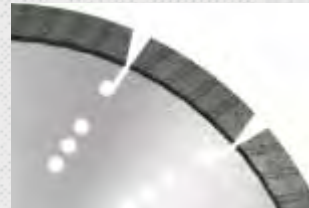

4.

Turbo segments

- ▶ exceptionally smooth operation
- ▶ clean cutting edges
- ▶ fast cutting speed
- ▶ long service life



5.

Short segments

- ▶ first-rate cutting performance
- ▶ clean cutting edges



6.

Wide gullet

- ▶ high feed rate



7.

Narrow gullet

- ▶ clean cut
- ▶ exceptionally smooth operation thanks to narrow segment spacings



8.

Hammer segments

- ▶ prevent rear grinding
- ▶ prevent segments tearing off
- ▶ optimal protection thanks to segments soldered in



9.

Continuous rim with special geometry

- ▶ for extra clean cutting edges
- ▶ soft and comfortable cutting performance



10.

Continuous rim with laser-cut slots

- ▶ for fine and clean cutting edges
- ▶ specially designed for ceramic and fine stoneware

Number of revolutions

Diamond tools made by Klingspor are high performance products and have been engineered to reach their highest level of performance at a level immediately below their maximum peripheral surface speeds. The maximum permissible values for motor speed and operating speed are indicated on every diamond blade. The table

below contains all permissible maximum speeds as a function of the diameter and the maximum permissible operating speed of the diamond tools.

		Maximum operating speed [m/s]									
		30	35	40	45	50	55	60	70	80	100
Ø [mm]	200	2.865	3.342	3.820	4.297	4.775	5.252	5.730	6.685	7.640	
	230	2.491	2.906	3.322	3.737	4.152	4.567	4.982	5.813	6.643	
	250	2.292	2.674	3.056	3.438	3.820	4.202	4.584	5.348	6.112	
	300	1.910	2.228	2.547	2.865	3.183	3.502	3.820	4.456	5.093	6.360
	350	1.637	1.910	2.183	2.456	2.728	3.001	3.274	3.820	4.366	5.450
	400	1.432	1.671	1.910	2.149	2.387	2.626	2.865	3.342	3.820	4.770
	450	1.273	1.485	1.698	1.910	2.122	2.334	2.547	2.971	3.395	4.240
	500	1.146	1.337	1.528	1.719	1.910	2.101	2.292	2.674	3.056	3.810
	550	1.042	1.215	1.389	1.563	1.736	1.910	2.084	2.431	2.778	
	600	955	1.114	1.273	1.432	1.592	1.751	1.910	2.228	2.547	

Motor speeds and cooling water quantity

The recommended speed range

The chart illustrates the ideal speed range for drill bits as a function of the diameter and the maximum permissible operating speed.

Recommended cooling water quantity

Drill bits require cooling with water regardless of the material on which they are used. Refer to the right side of the table for the recommended quantity of cooling water.

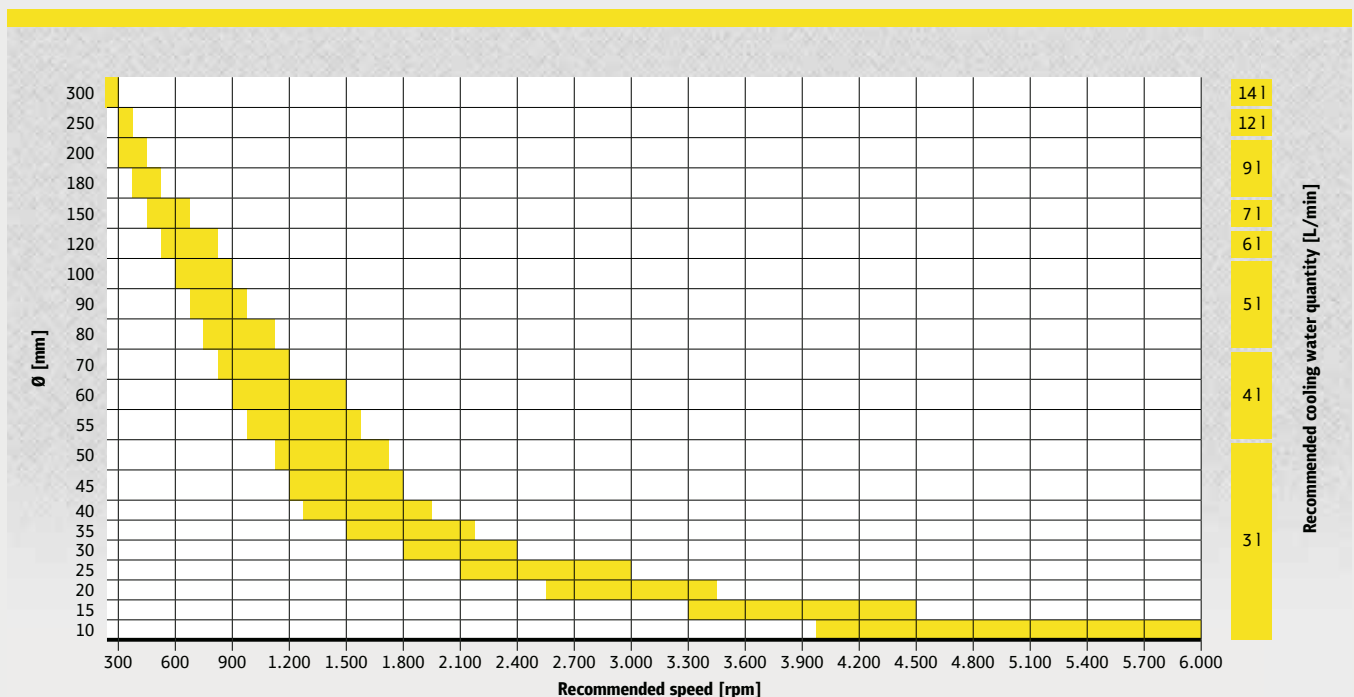

Diamond cutting blades for angle grinders

Universal

Diamond cutting blade

DT 600 U SUPRA



Properties

Design	Laser welded
Segmentation	Short segments
Aggression	■■■■■□□
Service life	■■■■■□□



Applications:

Construction materials	●
Concrete, universal	●
Cured concrete, reinforced	●
Chalky sandstone	●



• Short segments

Advantages: Suitable for a various range of applications - First-rate cutting performance - Exceptional service life thanks to the use of premium grade raw materials and diamonds - Clean cutting edges

Diameter x Bore in mm	Max. operating speed	Max. RPM	Segment in mm Number / Length / Width / Height	Packing unit/pcs.	Cat. number	Price/piece AUD	Discount group
100 x 16	80 m/s	15300 rpm	11 / 20 / 2,4 / 9	1	325025	32.50 AUD	12
115 x 22,23	80 m/s	13300 rpm	13 / 20 / 2,4 / 9	1	322630	36.50 AUD	12
125 x 22,23	80 m/s	12200 rpm	15 / 20 / 2,4 / 9	1	322631	40.60 AUD	12
180 x 22,23	80 m/s	8500 rpm	22 / 20 / 2,6 / 9	1	322633	64.90 AUD	12
230 x 22,23	80 m/s	6600 rpm	30 / 20 / 2,6 / 9	1	322634	81.10 AUD	12

Universal

Diamond cutting blade

DT 612 UT SUPRA



Properties

Design	Laser welded
Segmentation	Turbo
Aggression	■■■■■□□
Service life	■■■■■□□



Applications:

Construction materials	●
Concrete, universal	●
Cured concrete, reinforced	●
Chalky sandstone	●



• Turbo segments
• Segment height 12 mm

Advantages: Special turbo segments for an extremely high cutting speed on almost all hard materials - Excellent service life even on reinforced concrete

Diameter x Bore in mm	Max. operating speed	Max. RPM	Segment in mm Number / Length / Width / Height	Packing unit/pcs.	Cat. number	Price/piece AUD	Discount group
115 x 22,23	80 m/s	13300 rpm	8 / 33 / 2,4 / 12	1	334044	38.40 AUD	12
125 x 22,23	80 m/s	12200 rpm	9 / 33 / 2,4 / 12	1	334045	42.80 AUD	12
180 x 22,23	80 m/s	8500 rpm	11 / 42 / 2,6 / 12	1	334046	68.20 AUD	12
230 x 22,23	80 m/s	6600 rpm	15 / 42 / 2,6 / 12	1	334047	85.30 AUD	12

Diamond cutting blades for angle grinders



Universal

Diamond cutting blade

DT 900 UT SPECIAL



Properties

Design	Sintered
Segmentation	Turbo continuous rim
Aggression	■ ■ ■ ■ ■ ■ □
Service life	■ ■ ■ ■ ■ □ □



Applications:

Concrete, universal	●
Construction materials	●
Roof tiles	●



• Wave-shaped core

Advantages: Wave-shaped steel core - Use on construction material - Clean cutting edges - High aggressiveness

Diameter x Bore in mm	Max. operating speed	Max. RPM	Segment in mm Number / Length / Width / Height	Packing unit/pcs.	Cat. number	Price/piece AUD	Discount group
100 x 16 / 22,23	80 m/s	15300 rpm	CR / CR / 2,2 / 10	1	330626	36.00 AUD	12
115 x 22,23	80 m/s	13300 rpm	CR / CR / 2,2 / 10	1	325364	40.30 AUD	12
125 x 22,23	80 m/s	12200 rpm	CR / CR / 2,2 / 10	1	325365	44.60 AUD	12
180 x 22,23	80 m/s	8500 rpm	CR / CR / 2,5 / 10	1	325366	71.40 AUD	12
230 x 22,23	80 m/s	6600 rpm	CR / CR / 2,5 / 10	1	325367	89.30 AUD	12

Tiles

Diamond cutting blade

DT 300 F EXTRA



Properties

Design	Sintered
Segmentation	Continuous rim
Aggression	■ ■ ■ □ □ □ □
Service life	■ ■ ■ □ □ □ □



Applications:

Tiles	●
Stove tiles	●

Advantages: Clean edges when used for cutting tiles - Attractively priced quality wheel

Diameter x Bore in mm	Max. operating speed	Max. RPM	Segment in mm Number / Length / Width / Height	Packing unit/pcs.	Cat. number	Price/piece AUD	Discount group
100 x 16 / 22,23	80 m/s	15300 rpm	CR / CR / 1,6 / 7	1	330623	14.60 AUD	12
115 x 22,23	80 m/s	13300 rpm	CR / CR / 1,6 / 7	1	325357	16.40 AUD	12
125 x 22,23	80 m/s	12200 rpm	CR / CR / 1,6 / 7	1	325358	18.30 AUD	12

Diamond tools

Diamond cutting blades for angle grinders

Tiles

Diamond cutting blade

DT 600 F SUPRA



Properties

Design	Sintered
Segmentation	Continuous rim
Aggression	■ ■ ■ ■ □ □ □ □
Service life	■ ■ ■ ■ □ □ □ □



Applications:

Stoneware	●
Stove tiles	●
Stove tiles, glazed	●

Advantages: Professional wheel for tiles and feldspar - For precision working - Short cutting-off times - Clean edges

Diameter x Bore in mm	Max. operating speed	Max. RPM	Segment in mm Number / Length / Width / Height	Packing unit/pcs.	Cat. number	Price/piece AUD	Discount group
100 x 16 / 22,23	80 m/s	15300 rpm	CR / CR / 1,6 / 7	1	330624	21.30 AUD	12
115 x 22,23	80 m/s	13300 rpm	CR / CR / 1,6 / 7	1	325368	23.60 AUD	12
125 x 22,23	80 m/s	12200 rpm	CR / CR / 1,6 / 7	1	325369	26.30 AUD	12
180 x 22,23	80 m/s	8500 rpm	CR / CR / 1,6 / 7	1	325371	42.10 AUD	12
230 x 22,23	80 m/s	6600 rpm	CR / CR / 1,9 / 7	1	325372	52.80 AUD	12

Tiles

Diamond cutting blade

DT 900 FL SPECIAL



Properties

Design	Sintered
Segmentation	Continuous rim, with laser-cut slots
Aggression	■ ■ ■ ■ ■ ■ □ □
Service life	■ ■ ■ ■ ■ ■ □ □



Applications:

Wall tiles	●
Floor tiles	●
Porcelain	●
Ceramics	●
Marble	●



• Closed edge with laser-cut slots

Advantages: High-precision tool for hard wall and floor tiles - Laser-cut slots for exceptionally smooth operation and perfectly cut edges

Diameter x Bore in mm	Max. operating speed	Max. RPM	Segment in mm Number / Length / Width / Height	Packing unit/pcs.	Cat. number	Price/piece AUD	Discount group
115 x 22,23	80 m/s	13300 rpm	CR / CR / 1,4 / 7	1	331042	47.60 AUD	12
125 x 22,23	80 m/s	12200 rpm	CR / CR / 1,4 / 7	1	331043	52.80 AUD	12

Diamond cutting blades for angle grinders



Tiles

Diamond cutting blade

DT 900 FT SPECIAL



Properties

Design	Sintered
Segmentation	Turbo continuous rim
Aggression	■■■■■■■■■
Service life	■■■■■■■□



Applications:

Stoneware	●
Stove tiles	●
Stove tiles, glazed	●
Granite	●



- Thin steel core
- With steel core reinforcement

Advantages: 1.4 mm thin professional blade for extremely demanding applications - Work results of superior quality - Continuous rim with turbo segments - Clean and nick-free edges

Diameter x Bore in mm	Max. operating speed	Max. RPM	Segment in mm Number / Length / Width / Height	Packing unit/pcs.	Cat. number	Price/piece AUD	Discount group
100 x 16 / 22,23	80 m/s	15300 rpm	CR / CR / 1,4 / 7,5	1	330627	39.00 AUD	12
115 x 22,23	80 m/s	13300 rpm	CR / CR / 1,4 / 7,5	1	325392	43.90 AUD	12
125 x 22,23	80 m/s	12200 rpm	CR / CR / 1,4 / 7,5	1	325393	48.70 AUD	12

Tiles

Diamond cutting blade

DT 900 FP SPECIAL



Properties

Design	Sintered
Segmentation	Continuous rim, with special geometry
Aggression	■■■■■■■■■
Service life	■■■■■■■□



Applications:

Hard floor tiles	●
Porcelain	●
Hard wall tiles	●
Hard fine stoneware	●
Ceramics	●



- Continuous rim with special geometry
- Extra thin steel core
- With steel core reinforcement

Advantages: Extra thin disc for hard tiles and porcelain - The special geometry allows for superior cutting speeds and perfectly cut edges

Diameter x Bore in mm	Max. operating speed	Max. RPM	Segment in mm Number / Length / Width / Height	Packing unit/pcs.	Cat. number	Price/piece AUD	Discount group
100 x 16 / 22,23	80 m/s	15300 rpm	CR / CR // 1,4 / 10	1	337140	48.80 AUD	12
115 x 22,23	80 m/s	13300 rpm	CR / CR // 1,4 / 10	1	331039	54.90 AUD	12
125 x 22,23	80 m/s	12200 rpm	CR / CR // 1,4 / 10	1	331040	61.20 AUD	12

Diamond tools

Diamond cup grinding wheels for angle grinders

Concrete

Diamond cup grinding wheel

DS 300 B EXTRA



Properties

Design	Brazed
Segmentation	Standard
Aggression	■ ■ ■ ■ □ □ □ □
Service life	■ ■ ■ ■ □ □ □ □

Applications:

Concrete	●
Screed	●
Construction materials	●

Advantages: Double row cup grinding wheel with outstanding stock removal performance - High aggressiveness at low force requirements - Exceptional price-performance ratio - M14 adapter available, see DZ 114

Diameter x Bore in mm	Cup grinding wheel height in mm	Max. operating speed	Max. RPM	Segment in mm Number / Width / Height	Packing unit/pcs.	Cat. number	Price/piece AUD	Discount group
125 x 22,23	24,5 mm	80 m/s	12200 rpm	18 / 7 / 5	1	325362	84.90 AUD	12

Concrete

Diamond cup grinding wheel

DS 600 B SUPRA



Properties

Design	Brazed
Segmentation	Standard
Aggression	■ ■ ■ ■ ■ □ □ □ □ □
Service life	■ ■ ■ ■ ■ □ □ □ □ □

Applications:

Concrete	●
Screed	●
Construction materials	●

Advantages: Double row cup grinding wheel for machining concrete and abrasive materials - Efficient dust extraction - Aggressive grinding performance - Long service life - M14 adapter available, see DZ 114

Diameter x Bore in mm	Cup grinding wheel height in mm	Max. operating speed	Max. RPM	Segment in mm Number / Width / Height	Packing unit/pcs.	Cat. number	Price/piece AUD	Discount group
100 x 16 / 22,23	20 mm	80 m/s	15300 rpm	16 / 8,5 / 5,5	1	330621	97.50 AUD	12
115 x 22,23	20 mm	80 m/s	13300 rpm	16 / 8,2 / 5,5	1	325377	110.00 AUD	12
125 x 22,23	23,5 mm	80 m/s	12200 rpm	20 / 7,2 / 5,5	1	325378	134.00 AUD	12
180 x 22,23	30,5 mm	80 m/s	8500 rpm	24 / 8 / 5,5	1	325379	195.00 AUD	12

Diamond cup grinding wheels for angle grinders



Concrete

Diamond cup grinding wheel

DS 600 S SUPRA



Properties

Design	Brazed
Segmentation	Standard
Aggression	■■■■■□□
Service life	■■■■■□□



Applications:

Concrete	●
Firebrick	●
Natural stone	●
Masonry	●
Brickwork	●



• Special geometry

Advantages: Excellent dust extraction thanks to specially designed (fan-shaped) opening - Low weight thanks to lightweight steel plate - Rugged performance and operation with minimum vibrations - M14 adapter available, see DZ 114

Diameter x Bore in mm	Cup grinding wheel height in mm	Max. operating speed	Max. RPM	Segment in mm Number / Width / Height	Packing unit/pcs.	Cat. number	Price/piece AUD	Discount group
100 x 16 / 22,23	20,5 mm	80 m/s	15300 rpm	16 / 7,2 / 5,5	1	331022	114.00 AUD	12
115 x 22,23	20,5 mm	80 m/s	13300 rpm	16 / 7,2 / 5,5	1	331023	128.00 AUD	12
125 x 22,23	20,5 mm	80 m/s	12200 rpm	16 / 7,2 / 5,5	1	331024	157.00 AUD	12
180 x 22,23	30,5 mm	80 m/s	8500 rpm	24 / 7,8 / 5,5	1	331025	228.00 AUD	12

Adapter M14

DZ 114



Advantages: For retooling diamond cup grinding wheels with a Ø 22.23 mm hole to an M14 spindle size - Suitable for all Klingspor diamond cup grinding wheels

Mounting	Packing unit/pcs.	Cat. number	Price/piece AUD	Discount group
thread M14	1	331332	54.87 AUD	14

Diamond tools

Diamond cutting blades for petrol powered cutters and table saws

Universal

Diamond cutting blade

DT 600 U SUPRA

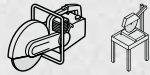
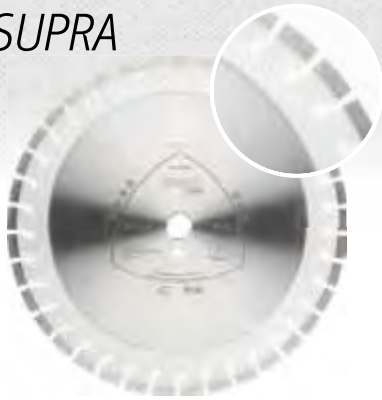

• Short segments

Properties

Design	Laser welded
Segmentation	Short segments
Aggression	■■■■■□□
Service life	■■■■■□□

Applications:

Construction materials	●
Concrete, universal	●
Cured concrete, reinforced	●
Chalky sandstone	●

Advantages: High cutting performance - Long service life thanks to the use of premium-grade raw materials and diamonds - Clean cutting edges - Effortless cutting thanks to short serrated segments

Diameter x Bore in mm	Max. operating speed	Max. RPM	Segment in mm Number / Length / Width / Height	Packing unit/pcs.	Cat. number	Price/piece AUD	Discount group
350 x 25,4	100 m/s	5500 rpm	37 / 24 / 3 / 10	1	325195	195.00 AUD	12
400 x 25,4	100 m/s	4800 rpm	43 / 24 / 3,2 / 10	1	325198	260.00 AUD	12

Universal

Diamond cutting blade

DT 900 U SPECIAL



Properties

Design	Laser welded
Segmentation	Narrow/wide gullet
Aggression	■■■■■■■
Service life	■■■■■■■

Applications:

Construction materials	●	Granite	●
Concrete, universal	●		
Cured concrete, reinforced	●		
Chalky sandstone	●		

Advantages: Suitable for a wide range of applications - Ultra fast cutting speed - Special segment bond for long service life and clean cuts - Engineered for professional use

Diameter x Bore in mm	Max. operating speed	Max. RPM	Segmen- tation	Segment in mm Number / Length / Width / Height	Packing unit/pcs.	Cat. number	Price/piece AUD	Discount group
350 x 25,4	100 m/s	5500 rpm		24 / 40 / 3 / 10	1	325100	269.00 AUD	12

Large diamond cutting blades for table saws



Universal

Diamond cutting blade

DT 900 US SPECIAL



Properties

Design	Laser welded
Segmentation	Narrow gullet
Aggression	■■■■■■■■■
Service life	■■■■■■■■■

Applications:

Cured concrete, reinforced	●
Concrete, universal	●
Construction materials	●
Chalky sandstone	●
Granite	●



• Low-noise sandwich core

Advantages: All-purpose high-performance tool - Extremely high cutting speed - Special segment bond for long service life and clean cuts - Engineered for professional use - Ideally suited for low-noise work environments thanks to sandwich core

Diameter x Bore in mm	Max. operating speed	Max. RPM	Segmentation	Segment in mm Number / Length / Width / Height	Packing unit/pcs.	Cat. number	Price/piece AUD	Discount group
350 x 25,4	100 m/s	5500 rpm		24 / 40 / 3 / 10	1	334063	350.00 AUD	12
400 x 25,4	100 m/s	4800 rpm		28 / 40 / 3,2 / 10	1	334064	466.00 AUD	12

Tiles

Diamond cutting blade

DT 900 FL SPECIAL



Properties

Design	Sintered
Segmentation	Continuous rim, with laser-cut slots
Aggression	■■■■■■■■□
Service life	■■■■■■■■□

Applications:

Wall tiles	●
Floor tiles	●
Porcelain	●
Ceramics	●
Marble	●



• Closed edge with laser-cut slots

Advantages: High-precision tool for hard wall and floor tiles - Laser-cut slots for exceptionally smooth operation and perfectly cut edges - Reduction ring from 30 mm to 25,4 mm included

Diameter x Bore in mm	Max. operating speed	Max. RPM	Segmentation	Segment in mm Number / Length / Width / Height	Packing unit/pcs.	Cat. number	Price/piece AUD	Discount group
180 x 25,4 / 30	100 m/s	10650 rpm		CR / CR / 1,6 / 7	1	331045	84.60 AUD	12
200 x 25,4 / 30	100 m/s	9550 rpm		CR / CR / 1,6 / 7	1	331046	100.00 AUD	12

Diamond tools

Diamond cutting blades for petrol powered cutters and joint cutters

Asphalt

Diamond cutting blade

DT 902 A SPECIAL



• Protective segments

Properties

Design	Laser welded
Segmentation	Wide gullet
Aggression	■■■■■■■■■
Service life	■■■■■■■■□

Applications:

Asphalt	●
Sandstone	●
Green concrete	●
Screed	●

Advantages: High cutting performance - 12 mm high segments - Protective segments to guard the blade

Diameter x Bore in mm	Max. operating speed	Max. RPM	Segmentation	Segment in mm Number / Length / Width / Height	Packing unit/pcs.	Cat. number	Price/piece AUD	Discount group
350 x 25,4	100 m/s	5500 rpm		21 / 40 / 3,2 / 12	1	325094	382.00 AUD	12
400 x 25,4	100 m/s	4800 rpm		24 / 40 / 3,4 / 12	1	325126	510.00 AUD	12

Asphalt

Diamond cutting blade

DT 612 AB SUPRA



• Protective segments
• Titanium-coated diamonds

Properties

Design	Laser welded
Segmentation	Wide gullet
Aggression	■■■■■■■■□
Service life	■■■■■■■■□

Applications:

Asphalt	●
Concrete	●

Advantages: Suitable for asphalt and concrete - Specially engineered for use on both materials - High cutting speed, excellent service life

Diameter x Bore in mm	Max. operating speed	Max. RPM	Segmentation	Segment in mm Number / Length / Width / Height	Packing unit/pcs.	Cat. number	Price/piece AUD	Discount group
350 x 20	100 m/s	5500 rpm		21 / 40 / 3,2 / 10	1	332345	302.00 AUD	12
350 x 25,4	100 m/s	5500 rpm		21 / 40 / 3,2 / 10	1	330081	302.00 AUD	12
400 x 25,4	100 m/s	4800 rpm		24 / 40 / 3,4 / 10	1	330082	404.00 AUD	12
450 x 25,4	100 m/s	4300 rpm		28 / 40 / 3,7 / 10	1	330083	504.00 AUD	12

Diamond cutting blade

DT 900 B SPECIAL



Properties

Design	Lasar welded
Segmentation	Turbo
Aggression	■■■■■■■■■■
Service life	■■■■■■■■■■



Applications:

Cured concrete, reinforced	●
Concrete, universal	●
Construction materials	●
Chalky sandstone	⓪



- Turbo segments
- Titanium-coated diamonds

Advantages: High performance blade with ultra high cutting speed thanks to turbo segments - Specially engineered for effortless cutting through concrete - Further increased service life thanks to titanium-coated diamonds

Diameter x Bore in mm	Max. operating speed	Max. RPM	Segment in mm				Packing unit/pcs.	Cat. number	Price/piece AUD	Discount group
			Number	Length	Width	Height				
350 x 25,4	100 m/s	5500 rpm	22	40	3	12	1	325081	243.00 AUD	12
400 x 25,4	100 m/s	4800 rpm	26	40	3,2	12	1	325114	325.00 AUD	12

Reduction rings

DZ 100 RR



Advantages: Reduction rings with serration for enhanced adhesion

Size in mm	Suitable for	Packing unit/pcs.	Cat. number	Price/piece AUD	Discount group
2,5 x 25,4 x 20	DT 602 A + DT 600 U	1	328934	9.39 AUD	14

Drill bits with 1 1/4" UNC connection

Concrete

1 1/4" UNC Female drill bit

DK 654 B
SUPRA



Properties

Design	Laser welded
Segmentation	Standard
Aggression	■■■■■■■□
Service life	■■■■■■■□



Applications:

Concrete, universal ●



• 11 mm high roofshaped segments

Advantages: Drill bits for universal applications - Very fast cutting - Long service life - Roof-shaped segments - Can be used on electric and hydraulic machines

Diameter in mm	Thread/Shaft	Effective length in mm	Segment in mm Number / Length / Width / Height	Packing unit/pcs.	Cat. number	Price/piece AUD	Discount group
52	thread 1 1/4"	450 mm	5 / 24 / 3,5 / 11	1	325769	140.00 AUD	12
66	thread 1 1/4"	450 mm	5 / 24 / 3,5 / 11	1	325773	158.00 AUD	12
76	thread 1 1/4"	450 mm	7 / 24 / 3,5 / 11	1	341737	174.00 AUD	12
82	thread 1 1/4"	450 mm	7 / 24 / 3,5 / 11	1	325775	193.00 AUD	12
102	thread 1 1/4"	450 mm	9 / 24 / 3,5 / 11	1	325777	216.00 AUD	12
112	thread 1 1/4"	450 mm	10 / 24 / 3,5 / 11	1	325778	247.00 AUD	12
125	thread 1 1/4"	450 mm	10 / 24 / 4 / 11	1	325780	290.00 AUD	12
152	thread 1 1/4"	450 mm	12 / 24 / 4 / 11	1	325783	351.00 AUD	12

Flexible abrasives

Hand block



Hand block

SFK 655



Properties

Bonding agent	Plastic
Grain	SiC

Applications:

Paint/Varnish	●	Leather	●
Glass/Stone	●	Metals	●
Wood	●		
Plastic	●		

Advantages: Universal hand block for cleaning and finishing - Can be used on many materials - Cleaning performance is significantly increased by use of additives - Soft abrasion due to elastic structure - Can be used until completely worn down

Available grits:

16	24	30	36	40	50	60	80	100	120	150	180	220	240	280	320	360	400	500	600	800	1000	1200	1500	2000
----	----	----	----	----	----	----	----	-----	-----	-----	-----	-----	-----	-----	-----	-----	-----	-----	-----	-----	------	------	------	------

Width x Length x Height in mm	Grit	Packing unit/pcs.	Cat. number	Price/piece AUD	Discount group
80 x 50 x 20	30	18	13800	10.53 AUD	13
80 x 50 x 20	60	18	13801	10.53 AUD	13
80 x 50 x 20	120	18	13802	10.53 AUD	13
80 x 50 x 20	240	18	13803	10.53 AUD	13

Hand block

SFK 655 Set



Properties

Bonding agent	Plastic
Grain	SiC

Applications:

Paint/Varnish	●	Leather	●
Glass/Stone	●	Metals	●
Wood	●		
Plastic	●		

Advantages: Universal hand block for cleaning and finishing - Can be used on many materials - Cleaning performance is significantly increased by use of additives - Soft abrasion due to elastic structure - Can be used until completely worn down - Contents: 18 pcs. / 6 pieces in grit 60, 120, 240 each

Available grits:

16	24	30	36	40	50	60	80	100	120	150	180	220	240	280	320	360	400	500	600	800	1000	1200	1500	2000
----	----	----	----	----	----	----	----	-----	-----	-----	-----	-----	-----	-----	-----	-----	-----	-----	-----	-----	------	------	------	------

Width x Length x Height in mm	Packing unit/pcs.	Cat. number	Price/piece AUD	Discount group
80 x 50 x 20	1	72129	191.16 AUD	13











Carbide burrs





About the product

Powerful milling and leveling of surfaces and forms

Klingspor carbide burrs are used wherever outstanding stock removal and service life are pivotal to the proper processing of hard-to-reach places. The burrs are manufactured according to the highest quality standards and with utmost precision. Our comprehensive product selection offers all shapes and dimensions

necessary to find the solution that matches each application best. Thanks to the abundance of available toothing options, you can be sure to achieve the desired outcome on any material and with unparalleled speed.

Type	Form
HF 100 A (ZYA)	 Cylindrical
HF 100 B (ZYAS)	 Cylindrical with end cut
HF 100 C (WRC)	 Cylindrical with spherical head
HF 100 D (KUD)	 Spherical shape
HF 100 E (TRE)	 Oval shape
HF 100 F (RBF)	 Conical shape
HF 100 G (SPG)	 Arch shape
HF 100 H	 Flame shape

Type	Form
HF 100 J (KSJ)	 Conical shape, pointed nose (60°)
HF 100 K (KSK)	 Conical shape, pointed nose (90°)
HF 100 L (KEL)	 Conical shape, round nose
HF 100 M (SKM)	 Conical shape, pointed nose
HF 100 N (WKN)	 Dovetail

Sets of burrs

HF 100	Set, 40 carbide burrs
HF 100	Set, 5 carbide burrs
HF 100 Steel	Set, 5 carbide burrs
HF 100 Inox	Set, 5 carbide burrs

Cut	Materials																							
	Steel						Soft NF metals				Hard NF metals				Creep resistant materials		Cast iron		Plastics					
	Carbon steel	Tool steel	Non-alloyed steel	Case-hardened steel	Cast steel	Alloyed steel	Hardened steel	Aluminium	Messing	Copper	Zinc	Bronze	Titanium	Titanium alloy	Aluminium alloy (high SiC contingent)	Nickel based alloy	Cobalt based alloy	Grey cast iron	White cast iron	GRP	CFRP	Ebonite / Hard rubber	Thermoplastic material	Thermosets
2	●	●	●	●	●	●			●	●	●	●	●	●	●	●	●	●	●					●
3							●		●	●	●												●	●
6	●	●	●	●	●	●			●	●		●	●	●	●	●	●	●	●	●	●			●
10	●	●	●	●	●	●												●	●					
11																	●	●						

● = main application ○ = possible application

Carbide burrs

Applications guide

The cuts at a glance

2 Cuts

Standard cut / plain cut with good finishing properties for universal applications



3 Cuts aluminium

High stock removal rate and reduced clogging of teeth for working on long-chipping and soft materials like NF metals and plastics



6 Cuts mega seller

Double cut for universal applications, improved handling and low vibration. Creates a small chip.

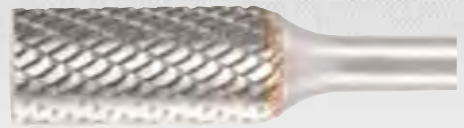

New high performance tooth geometries for steel and INOX processing

Perfectly adapted to the respective group of processed material, the newly engineered blade geometries 10 (steel) and 11 (INOX) allow for a significantly higher stock removal rate when compared to the cross-cut toothing typically found on ordinary burrs.

The advantages at a glance:

- ▶ higher level of aggressiveness and cutting performance
- ▶ improved chip removal
- ▶ markedly enhanced service life thanks to reduced built-up edge formation
- ▶ less thermal stress on tool and workpiece
- ▶ decrease in annealing colours during INOX applications

10 cuts high performance tooth geometry - steel

Toothing optimised for steel processing; significantly higher stock removal rate compared to a standard cross-cut tooth geometry



11 cuts high performance tooth geometry - INOX

Toothing optimised for the processing of austenitic as well as corrosion and acid-resistant grades of stainless steel; strikingly improved stock removal performance by contrast with standard cross-cut tooth geometries



Additional cuts available on request!



Important safety recommendations

- ▶ Please ensure that a maximum 30% of the tools circumference is in contact with the workpiece
- ▶ Extra long burrs with extended shank require slower operating speeds
- ▶ Ensure the burr is clamped correctly in a regularly maintained operating tool
- ▶ Run the selected burr at the correct operating speed to avoid risks and to ensure an optimum tool performance
- ▶ Please observe the safety recommendations on the packaging

Maximum operating speeds

Burr head in mm	Max. RPM
2/2,4/3	100,000
4/4,8/5/6/6,3	65,000
8/9,6/10/11	55,000
12/12,7	35,000
16	25,000
19,2	20,000
25,4	15,000

Recommended operating speeds

Burr head diameter in mm	Optimal speed range (RPM), depending on materials			
	The values in brackets are recommended starting speeds (start points) if no empirical values are already available			
	NF metals	Aluminium, plastic	Unhardened steels	Hardened steels, stainless steel
2/2,4/3	45,000	60,000	60,000	60,000
	(65,000)	(65,000)	(80,000)	(80,000)
	up to 80,000	up to 80,000	up to 80,000	up to 80,000
4/4,8/5/6/6,3	22,000	15,000	45,000	30,000
	(45,000)	(40,000)	(50,000)	(40,000)
	up to 60,000	up to 60,000	up to 60,000	up to 45,000
8/9,6/10/11	15,000	10,000	30,000	19,000
	(30,000)	(25,000)	(30,000)	(25,000)
	up to 40,000	up to 50,000	up to 40,000	up to 30,000
12/12,7	11,000	7,000	22,000	15,000
	(25,000)	(20,000)	(25,000)	(20,000)
	up to 30,000	up to 30,000	up to 30,000	up to 22,000
16	9,000	6,000	18,000	12,000
	(20,000)	(15,000)	(20,000)	(15,000)
	up to 20,000	up to 20,000	up to 20,000	up to 18,000
19,2	8,000	5,000	15,000	10,000
	(12,000)	(10,000)	(15,000)	(10,000)
	up to 17,000	up to 17,000	up to 17,000	up to 15,000
25,4	6,000	4,000	10,000	7,000
	(10,000)	(8,000)	(10,000)	(8,000)
	up to 13,000	up to 13,000	up to 13,000	up to 11,000

Carbide burrs

Carbide burr

HF 100 B

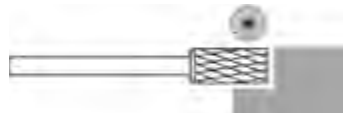

Properties: Cylindrical burr with end cut - Designation in accordance with DIN 8032: ZYAS

Advantages: The end cut makes it suitable for blind holes and faces on inner contours

Diameter in mm	Height in mm	Total length in mm	Shaft diameter in mm	Cut	Packing unit/pcs.	Cat. number	Price/piece AUD	Discount group
6	18	50	6	6	1	295532	33.52 AUD	14
8	19	64	6	6	1	295553	43.87 AUD	14
9,6	19	64	6	6	1	295569	47.15 AUD	14
12,7	25	70	6	6	1	295610	72.06 AUD	14
6	18	51	6,35	6	1	310209	33.52 AUD	14
8	19	64	6,35	6	1	310210	43.87 AUD	14
9,6	19	64	6,35	6	1	310211	47.15 AUD	14
12,7	25	70	6,35	6	1	310212	72.06 AUD	14

Carbide burr

HF 100 C

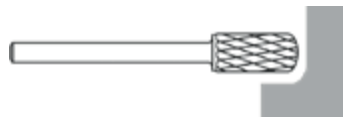

Properties: Cylindrical burr with ball end - Designation in accordance with DIN 8032: WRC

Advantages: For universal use on surfaces, contours and radiuses

Diameter in mm	Height in mm	Total length in mm	Shaft diameter in mm	Cut	Packing unit/pcs.	Cat. number	Price/piece AUD	Discount group
6	18	50	6	6	1	295694	35.46 AUD	14
8	19	63	6	6	1	295713	43.44 AUD	14
9,6	19	63	6	6	1	295727	47.77 AUD	14
12,7	25	70	6	6	1	295753	75.02 AUD	14
6	18	51	6,35	6	1	310213	35.46 AUD	14
8	19	64	6,35	6	1	310214	43.44 AUD	14
9,6	19	64	6,35	6	1	310275	47.77 AUD	14
12,7	25	70	6,35	6	1	310276	75.02 AUD	14

Carbide burr

HF 100 F



Properties: Semi-circular burr - Designation in accordance with DIN 8032: RBF

Advantages: Well suited for working on moulded parts



Diameter in mm	Height in mm	Total length in mm	Shaft diameter in mm	Cut	Packing unit/pcs.	Cat. number	Price/piece AUD	Discount group
6	18	50	6	6	1	295971	37.06 AUD	14
9,6	19	64	6	6	1	295987	46.70 AUD	14
8	20	65	6	6	1	295978	43.63 AUD	14
12,7	25	70	6	6	1	296010	68.80 AUD	14
6	18	51	6,35	6	1	310277	37.06 AUD	14
9,6	19	64	6,35	6	1	310279	46.70 AUD	14
8	20	65	6,35	6	1	310278	43.63 AUD	14
12,7	25	70	6,35	6	1	310280	68.80 AUD	14

Carbide burr

HF 100 G



Properties: Pointed arch-shaped burr with flattened tip - Designation in accordance with DIN 8032: SPG

Advantages: Ideal for chamfering - For deburring bore holes



Diameter in mm	Height in mm	Total length in mm	Shaft diameter in mm	Cut	Packing unit/pcs.	Cat. number	Price/piece AUD	Discount group
6	18	50	6	6	1	296062	37.06 AUD	14
8	19	64	6	6	1	296066	43.86 AUD	14
9,6	19	64	6	6	1	296074	49.83 AUD	14
12,7	25	70	6	6	1	296086	67.79 AUD	14
6	18	51	6,35	6	1	310281	37.06 AUD	14
8	19	64	6,35	6	1	310282	43.86 AUD	14
9,6	19	64	6,35	6	1	310283	49.83 AUD	14
12,7	25	70	6,35	6	1	310284	67.79 AUD	14

Carbide burrs

Carbide burr

HF 100 L



Properties: Conical round-nosed burr - Designation in accordance with DIN 8032: KEL

Advantages: For difficult-to-access areas

Diameter in mm	Height in mm	Total length in mm	Shaft diameter in mm	Cut	Packing unit/pcs.	Cat. number	Price/piece AUD	Discount group
6	18	50	6	6	1	296200	37.89 AUD	14
8	25,4	70	6	6	1	296205	50.04 AUD	14
9,6	30	76	6	6	1	296201	59.73 AUD	14
12,7	32	77	6	6	1	296192	72.96 AUD	14
6	18	51	6,35	6	1	310286	37.89 AUD	14
8	25,4	70	6,35	6	1	310288	50.04 AUD	14
9,6	30	76	6,35	6	1	310287	59.73 AUD	14
12,7	32	77	6,35	6	1	310285	72.96 AUD	14

Carbide burr

HF 100 Set



Properties: 5 top sellers (B, C, D, F, L) from our carbide burr programme in cut 3 (suitable for aluminium) in a handy box for a safe storage - **Available with shaft diameter of 6 mm and 6,35 mm**

Advantages: Presentation of the top sellers - Practical and safe storage of the burrs

Box size in mm	Shaft diameter in mm	Cut	Packing unit/pcs.	Cat. number	Price/piece AUD	Discount group
70 x 100	6	3	1	317869	351.68 AUD	14
70 x 100	6,35	3	1	317870	351.68 AUD	14

Carbide burr

HF 100 Set



Properties: 10-piece burr set, cut 6, in lockable Klingspor presentation box - Contents: Form B, C, F, G and L

Advantages: All top sellers at a glance

Box size in mm	Shaft diameter in mm	Cut	Packing unit/pcs.	Cat. number	Price/piece AUD	Discount group
144 x 100 x 44	6,35	6	1	338020	600.89 AUD	14

Carbide burr

HF 100 Set



Properties: 5 top sellers (B, C, F, G) from our carbide burr programme in cut 6 in a handy box for a safe storage - **Available with shaft diameter of 6 mm and 6,35 mm**

Advantages: Presentation of the top sellers - Practical and safe storage of the burrs

Size in mm	Cut	Packing unit/pcs.	Cat. number	Price/piece AUD	Discount group
6	6	1	309577	256.70 AUD	14
6,35 mm	6	1	310743	256.70 AUD	14



13 807 92
100 x 360 mm
P 117
1 x 1



Retail range

The ideal presentation for coated abrasives

Klingspor offers a display system for an attractive and sales promoting presentation of the products.

The compact space saving display system allows an efficient use of the sales area.

Klingspor's expert advisors are at your disposal.

The complete range available

- ▶ The relevant grit ranges and assortments in customised packing units
- ▶ Uniform packing design, precise product identification for quick access

Product pyramid

With our new point of sale display you give Klingspor products the appropriate appearance!

- ▶ Stylish: Visual appearance and design of the point of sale display guarantee a maximum of attention.
- ▶ Space-saving: Our pyramid does not need a lot of space. This saves sales area and offers your customers a perfect possibility of presenting the Klingspor products.

Retail range

Finishing paper

PL 31 B



Properties

Bonding agent	Glue
Grain	Aluminium oxide
Coating	Semi-open
Backing	B-paper

Applications:

Paint/Varnish/Filler	●
Wood	●
Metals	◐

Advantages: Product with optimal price-performance ratio - Optimized wear properties for hand sanding and handheld machine sanding

Available grits:

16 24 30 36 40 50 60 80 100 120 150 180 220 240 280 320 360 400 500 600 800 1000 1200 1500 2000

Width x Length in mm	Content of 1 selling unit	Content of 1 pack	Cat. number	Price/roll AUD	Price/pack AUD	Discount group
115 x 5000	1 x Grit 40 roll	5 Selling Units (5 rolls)	241817	18.71 AUD	93.55 AUD	1
115 x 5000	1 x Grit 60 roll	5 Selling Units (5 rolls)	241818	15.24 AUD	76.20 AUD	1
115 x 5000	1 x Grit 80 roll	5 Selling Units (5 rolls)	241819	13.70 AUD	68.50 AUD	1
115 x 5000	1 x Grit 120 roll	5 Selling Units (5 rolls)	241820	12.55 AUD	62.75 AUD	1
115 x 5000	1 x Grit 180 roll	5 Selling Units (5 rolls)	241821	12.55 AUD	62.75 AUD	1

1 pack (minimum order quantity) = 5 Selling Units = 5 Rolls

Abrasive cloth

LS 309 XH



Properties

Bonding agent	Resin
Grain	Aluminium oxide
Coating	Close
Backing	X-cotton

Applications:

Wood	●
Metals	●
NF metals	●
Paint/Varnish/Filler	◐

Advantages: Special type for portable belt sanders - For universal use on wood, metal, paint and varnish - Large product mix of belts for all standard machines

Available grits:

16 24 30 36 40 50 60 80 100 120 150 180 220 240 280 320 360 400 500 600 800 1000 1200 1500 2000

Width x Length in mm	Content of 1 selling unit	Belt joint	Content of 1 pack	Cat. number	Price/belt AUD	Price/pack AUD	Discount group
75 x 457	3 x Grit 40 belts	F5	6 Selling Units (18 belts)	9189	5.66 AUD	101.94 AUD	4
75 x 457	3 x Grit 60 belts	F5	6 Selling Units (18 belts)	9176	5.31 AUD	95.58 AUD	4
75 x 457	3 x Grit 80 belts	F5	6 Selling Units (18 belts)	9172	5.13 AUD	92.40 AUD	4
75 x 457	3 x Grit 120 belts	F5	6 Selling Units (18 belts)	7138	5.01 AUD	90.18 AUD	4
75 x 533	3 x Grit 40 belts	F5	6 Selling Units (18 belts)	7018	6.12 AUD	110.22 AUD	4
75 x 533	3 x Grit 60 belts	F5	6 Selling Units (18 belts)	7019	5.72 AUD	102.90 AUD	4
75 x 533	3 x Grit 80 belts	F5	6 Selling Units (18 belts)	7020	5.49 AUD	98.76 AUD	4
75 x 533	3 x Grit 120 belts	F5	6 Selling Units (18 belts)	7022	5.36 AUD	96.54 AUD	4

Other sizes available on request.

Continuation →

→ Continuation of LS 309 XH , Abrasive cloth

Width x Length in mm	Content of 1 selling unit	Belt joint	Content of 1 pack	Cat. number	Price/belt AUD	Price/pack AUD	Discount group
100 x 610	3 x Grit 40 belts	F5	6 Selling Units (18 belts)	7080	7.95 AUD	143.04 AUD	4
100 x 610	3 x Grit 60 belts	F5	6 Selling Units (18 belts)	7081	7.31 AUD	131.58 AUD	4
100 x 610	3 x Grit 80 belts	F5	6 Selling Units (18 belts)	7082	7.01 AUD	126.18 AUD	4
100 x 610	3 x Grit 120 belts	F5	6 Selling Units (18 belts)	7084	6.83 AUD	123.00 AUD	4

1 pack (minimum order quantity) = 6 Selling Units = 18 belts

Abrasive cloth, waterproof

CS 416 Y

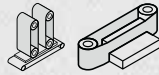

Properties

Bonding agent	Resin
Grain	Zirconia alumina
Coating	Semi-open
Backing	Y-polyester

Applications:

Stainless steel	●
Plastic	●
NF metals	⓪

Advantages: Very high aggressiveness and abrasive performance - Long service life also when used on materials that cause clogging

Available grits:

16	24	30	36	40	50	60	80	100	120	150	180	220	240	280	320	360	400	500	600	800	1000	1200	1500	2000
----	----	----	----	----	----	----	----	-----	-----	-----	-----	-----	-----	-----	-----	-----	-----	-----	-----	-----	------	------	------	------

Width x Length in mm	Content of 1 selling unit	Belt joint	Content of 1 pack	Cat. number	Price/belt AUD	Price/pack AUD	Discount group
50 x 915	4 x Grit 40 belts	F4G	3 Selling Units (12 belts)	342973	10.12 AUD	121.44 AUD	4
50 x 915	4 x Grit 60 belts	F4G	3 Selling Units (12 belts)	342976	9.20 AUD	110.40 AUD	4
50 x 915	4 x Grit 80 belts	F4G	3 Selling Units (12 belts)	342974	8.76 AUD	105.12 AUD	4
50 x 915	4 x Grit 120 belts	F4G	3 Selling Units (12 belts)	342975	8.48 AUD	101.76 AUD	4

1 pack (minimum order quantity) = 3 Selling Units = 12 belts

Abrasive cloth, waterproof

CS 416 Y Set

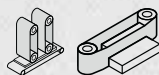

Properties

Bonding agent	Resin
Grain	Zirconia alumina
Coating	Semi-open
Backing	Y-polyester

Applications:

Stainless steel	●
Plastic	●
NF metals	⓪

Advantages: Very high aggressiveness and abrasive performance - Long service life also when used on materials that cause clogging

Available grits:

16	24	30	36	40	50	60	80	100	120	150	180	220	240	280	320	360	400	500	600	800	1000	1200	1500	2000
----	----	----	----	----	----	----	----	-----	-----	-----	-----	-----	-----	-----	-----	-----	-----	-----	-----	-----	------	------	------	------

Width x Length in mm	Content of 1 selling unit	Belt joint	Content of 1 pack	Cat. number	Price/belt AUD	Price/pack AUD	Discount group
50 x 915	Mixed pack - 1 of each belt, Grit 40/60/80	F4G	3 Selling Units (12 belts)	342987	9.36 AUD	112.32 AUD	4

Other sizes available on request.

Retail range

Abrasive fibre disc

CS 561



Properties

Bonding agent	Resin
Grain	Aluminium oxide
Coating	Close

Applications:

Steel	●	Stainless steel	⓪
NF metals	●	Wood	⓪
Metals	●		
Plastic	⓪		

Advantages: For universal use - Largest selection of diameters, grit sizes and hole patterns

Available grits:

16 24 30 36 40 50 60 80 100 120 150 180 220 240 280 320 360 400 500 600 800 1000 1200 1500 2000

Diameter x Hole in mm	Content of 1 selling unit	Hole pattern	Content of 1 pack	Cat. number	Price/disc AUD	Price/pack AUD	Discount group
115 x 22	5 x Grit 24 discs	⊗ 30	5 Selling Units (25 discs)	255905	1.79 AUD	44.75 AUD	8
115 x 22	5 x Grit 40 discs	⊗ 30	5 Selling Units (25 discs)	255906	1.50 AUD	37.55 AUD	8
115 x 22	5 x Grit 60 discs	⊗ 30	5 Selling Units (25 discs)	255907	1.32 AUD	32.95 AUD	8
115 x 22	5 x Grit 80 discs	⊗ 30	5 Selling Units (25 discs)	255908	1.28 AUD	32.05 AUD	8
115 x 22	5 x Grit 120 discs	⊗ 30	5 Selling Units (25 discs)	255909	1.28 AUD	32.05 AUD	8
125 x 22	5 x Grit 24 discs	⊗ 30	5 Selling Units (25 discs)	255910	2.08 AUD	51.90 AUD	8
125 x 22	5 x Grit 40 discs	⊗ 30	5 Selling Units (25 discs)	255911	1.73 AUD	43.35 AUD	8
125 x 22	5 x Grit 60 discs	⊗ 30	5 Selling Units (25 discs)	255912	1.52 AUD	38.00 AUD	8
125 x 22	5 x Grit 80 discs	⊗ 30	5 Selling Units (25 discs)	255913	1.48 AUD	37.00 AUD	8
125 x 22	5 x Grit 120 discs	⊗ 30	5 Selling Units (25 discs)	255914	1.48 AUD	37.00 AUD	8

1 pack (minimum order quantity) = 5 Selling Units = 25 discs

Other sizes available on request.

Abrasive paper, self-fastening

PS 22 K

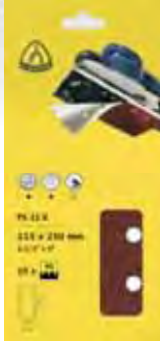

Properties

Bonding agent	Resin
Grain	Aluminium oxide
Coating	Semi-open
Backing	E-paper

Applications:

Wood	●	Plastic	●
Metals	●		
Stainless steel	○		
Paint/Varnish/Filler	○		

Advantages: High removal rate - Uniform scratch pattern

Available grits:

16	24	30	36	40	50	60	80	100	120	150	180	220	240	280	320	360	400	500	600	800	1000	1200	1500	2000
----	----	----	----	----	----	----	----	-----	-----	-----	-----	-----	-----	-----	-----	-----	-----	-----	-----	-----	------	------	------	------

Width x Length in mm	Content of 1 selling unit	Hole pattern	Content of 1 pack	Cat. number	Price/strip AUD	Price/pack AUD	Discount group
115 x 230	10 x Grit 40 strips	GL 15	5 Selling Units (50 strips)	241663	2.46 AUD	123.00 AUD	7
115 x 230	10 x Grit 60 strips	GL 15	5 Selling Units (50 strips)	241664	2.00 AUD	100.00 AUD	7
115 x 230	10 x Grit 80 strips	GL 15	5 Selling Units (50 strips)	241665	1.76 AUD	88.15 AUD	7
115 x 230	10 x Grit 120 strips	GL 15	5 Selling Units (50 strips)	241666	1.63 AUD	81.25 AUD	7

1 pack (minimum order quantity) = 50 sheets

Abrasive paper, self-fastening

PS 22 K



Properties

Bonding agent	Resin
Grain	Aluminium oxide
Coating	Semi-open
Backing	E-paper

Applications:

Wood	●	Plastic	●
Metals	●		
Stainless steel	○		
Paint/Varnish/Filler	○		

Advantages: Universal abrasive disc for metalworking and woodworking - Uniform surface scratch pattern - Available in many grit sizes and dimensions

Available grits:

16	24	30	36	40	50	60	80	100	120	150	180	220	240	280	320	360	400	500	600	800	1000	1200	1500	2000
----	----	----	----	----	----	----	----	-----	-----	-----	-----	-----	-----	-----	-----	-----	-----	-----	-----	-----	------	------	------	------

Diameter in mm	Content of 1 selling unit	Hole pattern	Content of 1 pack	Cat. number	Price/disc AUD	Price/pack AUD	Discount group
96	5 x Grit 40 discs	GLS 15	5 Selling Units (25 discs)	241656	1.37 AUD	34.25 AUD	7
96	5 x Grit 60 discs	GLS 15	5 Selling Units (25 discs)	241657	1.15 AUD	28.75 AUD	7
96	5 x Grit 80 discs	GLS 15	5 Selling Units (25 discs)	241658	1.05 AUD	26.15 AUD	7
96	5 x Grit 120 discs	GLS 15	5 Selling Units (25 discs)	241659	0.98 AUD	24.55 AUD	7

1 pack (minimum order quantity) = 5 Selling Units = 25 discs

Other sizes available on request.

Retail range

Abrasive paper, self-fastening

PS 22 K



Properties

Bonding agent	Resin
Grain	Aluminium oxide
Coating	Semi-open
Backing	E-paper

Applications:

Wood	●	Plastic	⦿
Metals	●		
Stainless steel	⦿		
Paint/Varnish/Filler	⦿		

Advantages: Universal abrasive disc for metalworking and woodworking - Uniform surface scratch pattern - Available in many grit sizes and dimensions

Available grits:

16 24 30 36 40 50 60 80 100 120 150 180 220 240 280 320 360 400 500 600 800 1000 1200 1500 2000																				
Diameter in mm	Content of 1 selling unit	Hole pattern	Content of 1 pack	Cat. number	Price/disc AUD	Price/pack AUD	Discount group													
125	5 x Grit 40 discs	○ 0	5 Selling Units (25 discs)	278810	2.00 AUD	50.00 AUD	7													
125	5 x Grit 60 discs	○ 0	5 Selling Units (25 discs)	278811	1.65 AUD	41.20 AUD	7													
125	5 x Grit 80 discs	○ 0	5 Selling Units (25 discs)	278812	1.48 AUD	37.00 AUD	7													
125	5 x Grit 120 discs	○ 0	5 Selling Units (25 discs)	278813	1.37 AUD	34.35 AUD	7													
125	5 x Grit 180 discs	○ 0	5 Selling Units (25 discs)	278814	1.37 AUD	34.35 AUD	7													
125	5 x Grit 40 discs	⊗ GLS 5	5 Selling Units (25 discs)	241614	2.04 AUD	50.90 AUD	7													
125	5 x Grit 60 discs	⊗ GLS 5	5 Selling Units (25 discs)	241625	1.68 AUD	41.95 AUD	7													
125	5 x Grit 80 discs	⊗ GLS 5	5 Selling Units (25 discs)	241626	1.51 AUD	37.75 AUD	7													
125	5 x Grit 120 discs	⊗ GLS 5	5 Selling Units (25 discs)	241627	1.40 AUD	35.10 AUD	7													
125	5 x Grit 180 discs	⊗ GLS 5	5 Selling Units (25 discs)	241628	1.40 AUD	35.10 AUD	7													
150	5 x Grit 40 discs	⊗ GLS 51	5 Selling Units (25 discs)	319068	2.67 AUD	66.80 AUD	7													
150	5 x Grit 60 discs	⊗ GLS 51	5 Selling Units (25 discs)	319069	2.18 AUD	54.45 AUD	7													
150	5 x Grit 80 discs	⊗ GLS 51	5 Selling Units (25 discs)	319070	1.93 AUD	48.25 AUD	7													
150	5 x Grit 120 discs	⊗ GLS 51	5 Selling Units (25 discs)	319071	1.79 AUD	44.70 AUD	7													
150	5 x Grit 180 discs	⊗ GLS 51	5 Selling Units (25 discs)	319073	1.79 AUD	44.70 AUD	7													

1 pack (minimum order quantity) = 5 Selling Units = 25 discs

Other sizes available on request.

Abrasive paper, self-fastening

PS 22 K Set



Properties

Bonding agent	Resin
Grain	Aluminium oxide
Coating	Semi-open
Backing	E-paper

Applications:

Wood	●	Plastic	⦿
Metals	●		
Stainless steel	⦿		
Paint/Varnish/Filler	⦿		

Advantages: Universal abrasive disc for metalworking and woodworking - Uniform surface scratch pattern - Available in many grit sizes and dimensions

Set discs: Assortments in two pieces grit 40, two pieces grit 80 and two pieces grit 120

Available grits:

16	24	30	36	40	50	60	80	100	120	150	180	220	240	280	320	360	400	500	600	800	1000	1200	1500	2000
Width x Length in mm	Content of 1 selling unit	Hole pattern	Content of 1 pack	Cat. number	Price/set AUD	Price/pack AUD	Discount group																	
125	several grain sizes	⦿ GLS 5	Selling Units (30 discs)	241630	1.70 AUD	8.50 AUD	7																	

1 pack (minimum order quantity) = 30 discs in a pack

Cutting-off wheel

A 60 TZ SPECIAL



Class SPECIAL

Bond	■ ■ ■ ■ ■ □ □
Aggression	■ ■ ■ ■ ■ □ □
Service life	■ ■ ■ ■ ■ □ □

Applications:

Stainless steel	●
Steel	●
NF metals	⦿

Advantages: Free of iron, sulfur and chlorine - Short cutting times - Minimal burr formation - Low thermal load

Diameter x Width x Bore in mm	Form	Max. operating speed	Max. RPM	Content of 1 selling unit	Content of 1 pack	Cat. number	Price/disc AUD	Price/pack AUD	Discount group
100 x 1 x 16	—	80 m/s	15300 rpm	10 wheels	5 selling units (50 wheels)	326295	2.80 AUD	140.00 AUD	11
115 x 1 x 22,23	—	80 m/s	13300 rpm	10 wheels	5 selling units (50 wheels)	326296	3.04 AUD	151.75 AUD	11
125 x 1 x 22,23	—	80 m/s	12200 rpm	10 wheels	5 selling units (50 wheels)	326297	3.36 AUD	167.75 AUD	11

1 pack (minimum order quantity) = 50 cutting-off wheels

Other sizes available on request.

Point of Sale

Point of Sale

Flexible, easy care and maintenance, representative: The new, modular POS system by Klingspor

The full range of products – from the show room to one-on-one selling. It must be representative, boost sales and be easy to care for – the requirements for a POS are manifold and keep changing. The new POS system by Klingspor can be configured flexibly according to individual needs.

Flexibility

The new Klingspor POS system is flexibly scalable. Standardised modules with a width of one metre can be flexibly extended in height and width. All new POS elements are fully compatible with previous Klingspor POS modules.

Optimally representative

The image modules complement your POS presentation by true attention-getters. Depending on your line of goods, these modules can be fitted out flexibly. The main eye-catcher is a large work piece, on which typical application examples can be shown.

Minimal effort for care and maintenance

The modular design and easily exchangeable magnetic foils keep your wall up to date: Popular products and promotions that make for sales momentum can be installed on the wall with a few simple steps. Out-of-stock fast movers can be refilled directly at the POS through an optional storage space in the base rail.

Point of Sale Catalogue

Please request our Point of Sale Catalogue for more detailed information on the POS elements, modules and accessory.

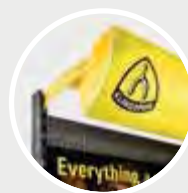

Backlit top panels

Simple but effective: With backlit top panels that disperse light to the front as well as on the products, you'll find it easy to attract attention to your POS.

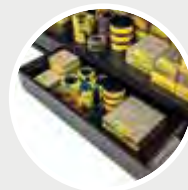

Optional storage space

Consultancy documents or much-in-demand fast movers for refilling the wall quickly can be stored easily in the storage space behind the base rail.



Flexible labelling due to detachable magnetic foils

Quick orientation, fewer questions and quickly placed.

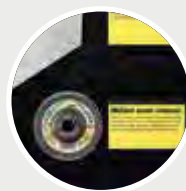

Representative image module

A true attention-getter – with user-oriented tasks, you can stage the highlight products in your line of goods. Beside a stainless steel hexagon with different machining examples, your own in-house work pieces can be set up.

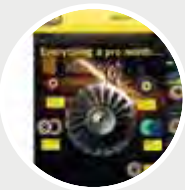

Individual designs are possible

Design the wall with individual eye-catchers that hit on the dot the work focus of your customers. We are glad to advise you!



Magnetic top panels

The magnetic foils can also be applied to the centre gondola and enable easy care and maintenance as well as quick orientation.

Safety recommendations

Applications guide

General Principles of Safety

Abrasive products improperly used can be very dangerous.

- ▶ Always follow the instructions provided by the abrasive product and machine supplier.
- ▶ Ensure that the abrasive product is suitable for its intended use. Examine all abrasive products for damage or defects before use.
- ▶ Follow the correct procedures for handling and storage of abrasive products. Be aware of the hazards likely during the use of abrasive products and observe the recommended precautions to be taken:
 - ▶ Bodily contact with the abrasive product at operating speed.
 - ▶ Injury resulting from product breakage during use.
 - ▶ Grinding debris, sparks, fumes and dust generated by the grinding process.
 - ▶ Noise
 - ▶ Vibration

Use only abrasive products conforming to the highest standards of safety. These products will bear the relevant EN standard number and/or the inscription "oSa":

- ▶ EN 12413 for Bonded Abrasives.
- ▶ EN 13236 for Superabrasives.
- ▶ EN 13743 for Specific Coated Abrasives (vulcanised fibre discs, flap wheels, flap discs and spindle-mounted flap wheels).

Never use a machine that is not in good working order or one with defective parts. Employers should carry out a risk assessment on all individual abrasive processes to determine the appropriate protective measures necessary. They should ensure that their employees are suitably trained to carry out their duties.

More detailed information on the safe use of abrasive products, comprehensive Safety Codes are available from FEPA or your National Trade Association.

- ▶ FEPA Safety Code for Bonded Abrasives and Precision Superabrasives.
- ▶ FEPA Safety Code for Superabrasives for Stone and Construction.
- ▶ FEPA Safety Code for Coated Abrasives.

products 3 years, Rubber products 5 years, Vitrified products 10 years.

- ▶ Check abrasive product or package for any warnings or other safety information.
- ▶ Ensure that the correct abrasive product is selected. Never use a product if it cannot be properly identified.
- ▶ Follow the instructions provided by the abrasive product or machine supplier when mounting abrasive products. Observe any mounting indications marked on the product such as direction of run or mounting position.
- ▶ Never force the abrasive product onto the mounting fixture or modify it to fit.
- ▶ Never exceed the maximum operating speed where specified.
- ▶ Check that the correct mounting devices are used and that they are undistorted, clean and free from burrs.
- ▶ Use mounting blotters where supplied.
- ▶ Do not tighten the mounting device excessively.
- ▶ After mounting or re-mounting an abrasive product, conduct a trial run at operating speed with the guard in place for at least 30 seconds, standing clear of the machine before use.
- ▶ Never remove guards from machines where fitted and ensure they are in good condition and properly adjusted.
- ▶ Ensure that the workpiece is secure and properly supported. Ensure that work rests are properly adjusted and secure.
- ▶ Never start the machine with the workpiece in contact with the abrasive product.
- ▶ Never apply excessive force or shock to the abrasive product or let it overheat.
- ▶ Do not grind on the part of the product that is not designed for the operation.
- ▶ Avoid grinding with the edge of abrasive belts, use the centre of the belt if possible.
- ▶ Avoid clogging and uneven wear to ensure that the abrasive product is working efficiently. Dress frequently where appropriate.
- ▶ Let the abrasive product stop naturally, not by applying pressure to its surface.
- ▶ Turn off and spin out excess coolant before stopping the machine.
- ▶ Do not leave abrasive belts under tension when not in use.

Precautions against likely hazards

Bodily contact with the abrasive product

- ▶ Always take great care and attention when using abrasive products. Tie back long hair and do not wear loose clothing, ties or jewellery.
- ▶ Prevent accidental start up of the machine before mounting or changing an abrasive product. Isolate machines from their power source where necessary.
- ▶ Never remove guards from machines where fitted and ensure they are in good condition and properly adjusted before starting the machine.
- ▶ Always use gloves and suitable clothing where the workpiece or machine is handheld. For gloves, a minimum protection level of EN 388 Category 2 is recommended.
- ▶ After switching off the machine, ensure the product has come to rest before leaving the machine unattended.

Injury caused by product breakage

- ▶ Always handle abrasives with great care, they are easily damaged. Examine all products for defects or damage before use.
- ▶ Store abrasives in dry, frost-free conditions avoiding wide variations in temperature. Ensure they are properly protected and supported to prevent damage and distortion.
- ▶ Coated abrasives should be stored at 18-22° C, 45-65% relative humidity.
- ▶ Abrasive belts should be hung on a rod or peg not less than 50mm diameter.
- ▶ Never use an abrasive product beyond its expiry date where marked. Observe the recommended shelf life for the following specific products; Resinoid and Shellac



Not permitted for handheld or manually-guided grinding



Do not use for wet grinding



Not permitted for face grinding



Do not use if damaged



Only permitted with a backing pad



Use ear muffs



Observe safety instructions



Wear safety gloves to protect hands



Wear safety goggles or glasses to protect the eyes



Wear a dust mask



Only permitted for wet cutting



Only permitted for use on totally enclosed machines

Safety recommendations

Applications guide



Grinding debris – sparks, dust and fumes

- ▶ Exposure to dust generated from workpiece and/or abrasive materials can result in lung damage and/or other physical injury.
- ▶ All dry grinding processes should be provided with adequate extraction facilities.
- ▶ Do not use abrasive products near flammable materials.
- ▶ The use of respirators complying with EN149 is recommended for dry grinding processes even if extraction systems are provided.
- ▶ Guards where provided should be adjusted to deflect sparks and debris away from the operator.
- ▶ Take additional measures to protect people working nearby.
- ▶ Eye protection is recommended for all machine applications for abrasives. For handheld machines or workpiece, goggles or full face shields are recommended.
- ▶ Eye protection with a minimum protection of EN166 Grade B is recommended.
- ▶ Ensure that the correct abrasive product is selected. An unsuitable product can produce excessive debris and dust.

Noise

- ▶ Ear protection complying with EN352 is recommended for all applications where the workpiece or machine is handheld, irrespective of the noise level.
- ▶ Ensure that the correct abrasive product is selected. An unsuitable product can produce excessive noise.

Vibration

- ▶ Processes where the workpiece or machine is handheld can cause vibration injury.
- ▶ Action needs to be taken if tingling, pins and needles or numbness is experienced after 10 minutes continuous use of the abrasive product.
- ▶ The effects of vibration are more pronounced in cold conditions so keep the hands warm and exercise hands and fingers regularly. Use modern equipment with low vibration levels.
- ▶ Maintain all equipment in good condition and stop the machine and have it checked if excessive vibration occurs.
- ▶ Use good quality abrasive products and keep them in good condition during their life.
- ▶ Maintain mounting flanges and backing pads in good condition and replace if worn or distorted.
- ▶ Do not grip the workpiece or machine too tightly and do not exert excessive pressure on the abrasive product.
- ▶ Avoid continuous use of the abrasive product.
- ▶ Use the correct product. An unsuitable product can produce excessive vibration.
- ▶ Don't ignore the physical symptoms of vibration – seek medical advice.

Disposal of abrasives

- ▶ Used or defective abrasives should be disposed in accordance with local or national regulations.
- ▶ Further information can be obtained from material safety data sheets provided by the supplier.
- ▶ Be aware that the abrasive product may be contaminated with material from the workpiece or process after use.
- ▶ Disposed abrasive products should be damaged to prevent them from being taken from waste skips and re-used.

SAFETY RECOMMENDATIONS FOR THE USE OF ABRASIVE BELTS

1. General safety recommendations

- ▶ Ensure that quality and dimensions of the belt are correct for the machine and type of application. Refer to the machine manufacturer's instructions.
- ▶ Do not use near easily flammable material.
- ▶ Prevent long hair, loose clothes or jewellery from getting into contact with the machine and being pulled in. Take precautionary measures.
- ▶ Ensure that people nearby are protected from chips, sparks, debris, fumes, dust and noise. Belt grinding operations may produce high concentrations of dust, gas or mist, which can represent a health hazard as well as a risk of explosion.
- ▶ Do not open the guard or put down the machine until the belt has come to a complete standstill.

2. Specific safety recommendations

- ▶ Abrasive belts can tear. Please take precautions against risks by tearing of belt (e.g. protective clothing and devices, safety equipment of machinery).
- ▶ Abrasive machines, which do not have a completely closed guard require comprehensive protective equipment of the user (e.g. protective gloves, leather aprons, face shield, dust mask).
- ▶ Check the locking mechanism of the machine cover. Do not remove guards. Any contact with running belts can result in serious injuries.
- ▶ When mounting, refer to direction of running advice, if necessary.
- ▶ Make sure the workpiece is held correctly or is mechanically secured.
- ▶ Start the machine and wait until belt has reached its full operational speed before grinding.
- ▶ Belts should only be used dry unless specified as suitable for wet grinding (please contact the manufacturer if in any doubt).
- ▶ Use the centre of the belt, if possible, and grind as flat as possible. Avoid grinding with the edge of the belt as well as strong punctual loading e.g. through sharp or sharp-edged workpieces.
- ▶ Do not exert excessive pressure and prevent the belt from overheating.
- ▶ Check the belts in use periodically for wear and tear or damage (e.g. cracks at edges, fracturing or strong wear and tear in the joint) and replace the belts if necessary.

Due to the extraordinary variety of applications and machine constructions, these recommendations are limited to basic aspects of safety. Further safety regulations and instructions can be taken from the respective legislation, decrees and technical standards.

KLINGSPOR AUSTRALIA PTY. LTD.

TERMS AND CONDITIONS OF SALE

1. DEFINITIONS & INTERPRETATION

1.1 Definitions

"Buyer" means the person who buys or agrees to buy the goods from the Company whose name and address are set out in the box marked "Buyer" **overleaf**.

"Company" means Klingspor Australia Pty Limited ACN 092 623 142.

"Conditions" means the terms and conditions of sale set out in this document and any special terms and conditions agreed in writing by the Company.

"Delivery" means when the Product is loaded and dispatched from the Company's warehouse or the commencement date for the performance of services.

"Delivery Date" means the date or range of dates set out overleaf which is specified by the Company when or within which range the Product is to be delivered.

"Price" means the Company's quoted price or the price set out overleaf at which the Buyer agrees to buy the Product.

"Product" means the goods which the Buyer agrees to buy from the Company in the quantity specified overleaf.

1.2 Interpretation

The following rules of interpretation shall apply to this Agreement:

(a) Words importing the singular will include the plural and vice versa and words importing any gender will include all genders and words importing a person shall include any other entity recognised by law and vice versa.

(b) Where the day on or by which any act matter or thing is required to be done is a day other than a Business Day in the place in which the act matter or thing is to be done, such act matter or thing shall be done on the next succeeding Business Day unless specifically provided for to the contrary in this Agreement.

(c) Headings and underlinings are for convenience only and do not affect the interpretation of this Agreement.

2. CONDITIONS APPLICABLE

- 2.1 These conditions shall apply to all contracts for the sale of Product by the Company to the Buyer to the exclusion of all other terms and conditions including any terms or conditions which the Buyer may purport to apply under any purchase order, confirmation of order or similar document.
- 2.2 All orders for Product shall be deemed to be an offer by the Buyer to purchase Product pursuant to these Conditions.
- 2.3 Any variation to these Conditions (including any special terms and conditions agreed between the parties) shall be inapplicable unless agreed in writing by the Company.

3. THE PRICE AND PAYMENT

- 3.1 The Price shall be the Company's quoted price or, if these terms are affixed to a purchase agreement or order confirmation, the price set out overleaf.
- 3.2 Unless otherwise stated all prices quoted by vendor are net, exclusive of Goods and Services Tax (GST).
- 3.3 The minimum value for all orders made by the Buyer to purchase Product from the Company shall be one hundred and seventy dollars (\$170.00) plus GST.
- 3.4 The Company may after acceptance of a customer's order, by giving notice to the Buyer at any time up to fourteen (14) days before delivery, increase the Price of the Product to reflect any increase in the cost to the Company which is due to factors occurring after the making of this Sales Agreement which are beyond the reasonable control of the Company (including, without limitation, foreign exchange fluctuations, taxes and duties and the cost of labour, materials and other manufacturing, transportation, and transportation related costs) provided that any such increase shall be limited to two per cent (2%) of the agreed Price. Foregoing clause 3.4 does not affect Company's right to adjust its pricing before acceptance of an order.
- 3.5 Payment of the Price shall be due within thirty (30) days of the date of statement and time for payment shall be of the essence.
- 3.6 Interest on overdue invoices shall accrue from the date when payment becomes due from day to day until the date of payment at a rate of fifteen per cent (15%) p.a. and shall accrue at such rate after as well as before any judgment.
- 3.7 The Buyer acknowledges and agrees any expenses costs or disbursements incurred by the Company in recovering any outstanding monies including debt collection agencies fees or legal fees, shall be recoverable from the Buyer on an indemnity basis.
- 3.8 Unless previously withdrawn, the Company's quotations are open for acceptance within the period stated in them or, when no period is so stated, within fourteen (14) days only after its date. The Company reserves the right to refuse any purchase order based on its quotation within seven (7) days after the receipt of the purchase order.

4. THE PRODUCT

- 4.1 The quantity and description of the Product shall be as set out respective offer, purchase agreement or order confirmation and as described in the product specifications issued by Company.
- 4.2 The Buyer shall take delivery of the Product tendered notwithstanding that the quantity so delivered shall be either greater or less than the quantity purchased provided that:
 - (a) the Buyer shall have given the Company notice in writing within twenty-four (24) hours of delivery of the discrepancy in quantity;
 - (b) such discrepancy in quantity shall not exceed five per cent (5%);
 - (c) the Price shall be adjusted pro rata to reflect any discrepancy; and

(d) if the Buyer fails to give notice in accordance with clause 4.2(a), the Product shall be deemed to be in all respects in accordance with this Agreement and the Buyer shall be bound to accept and pay for the Product accordingly.

5. WARRANTIES AND LIABILITIES

- 5.1 Any performance figures given by the Company are estimates only. The Company is under no liability for damages for failure of the Product to attain such figures unless specifically guaranteed in writing. Any such written guarantees are subject to the recognised tolerances applicable to such figures.
- 5.2 The Company warrants that the Product will at the time of delivery correspond to the description given by the Company.

6. GUARANTEE

- 6.1 The Company's liability for Product manufactured by it is limited to making good any defects by repairing the defects or at the Company's option by replacement, within a period not exceeding twelve (12) calendar months after the Product has been dispatched so long as:
 - (a) defects have arisen solely from faulty materials or workmanship;
 - (b) the Product has not received maltreatment, inattention or interference;
 - (c) accessories of any kind used by the Buyer are manufactured by or approved by Company;
 - (d) the seals of any kind on the goods remain unbroken; and
 - (e) the defective parts are promptly returned free of cost to the Company.
- 6.2 If the Product is not manufactured by the Company the warranty and/or guarantee of the manufacturer of those goods is accepted by the Buyer and is the only warranty or guarantee given to the Buyer in respect of the Product. The Company agrees to assign to the Buyer on request made by the Buyer the benefit of any warranty or entitlement to the goods that the manufacturer has granted to the Company under any contract or by implication or operation of law to the extent that the benefit of any warranty or entitlement is assignable.
- 6.3 The Company is not liable for and the Buyer releases the Company from any claims in respect of faulty or defective design of any product supplied unless such design has been wholly prepared by the Company and the responsibility for any claim has been specifically accepted by the Company in writing. In any event, the Company's liability under this Clause 6.3 is limited strictly to the replacement of defective parts in accordance with Clause 6.1 of this Agreement.
- 6.4 The Company excludes all express and implied conditions and warranties from these terms, except any condition or warranty (such as conditions and warranties implied by the Competition and Consumer Act 2010 (Cth) and equivalent State and Territory laws) which cannot by law be excluded ("Non-excludable Condition").
- 6.5 The Company's liability for breach of any Non-excludable Condition (to the extent such liability can be limited) arising in relation to the supply of goods other than goods of a kind ordinarily acquired for personal, domestic or household use or consumption, shall at the Company's option be limited to:
 - (a) the replacement of the goods or resupply of the goods by the Company, or the cost of replacement or resupply of the goods; or
 - (b) the repair of the goods, or the cost of repair of the goods.
- 6.6 Subject to clauses 6.4 and 6.5, the Company excludes all other liability to the Buyer for physical or financial injury, loss or damage or for consequential loss or damage of any kind arising out of the supply, layout, assembly, installation or operation of the Product or arising out of the Company's negligence or in any way whatsoever.

7. DELIVERY

- 7.1 The delivery times made known to the Buyer are estimates only and the Company is not be liable for late delivery or non-delivery.
- 7.2 The Company is not be liable for any loss and/or expense (including loss of profit), damage or delay occasioned to the Buyer or its customers arising from late or non-delivery or late installation of the Product.
- 7.3 The Company may at its option deliver the Product to the buyer in any number of instalments unless there is an endorsement overleaf to the effect that the buyer will not take delivery by instalments.
- 7.4 If the Company delivers any of the Product by instalments, and any one of those instalments is defective for any reason:
 - (a) it is not a repudiation of the Sales Agreement formed by these terms and conditions; and
 - (b) the defective instalment is a severable breach that gives rise only to a claim for compensation.
- 7.5 The Company is not responsible to the Buyer or any person claiming through the Buyer for any loss or damage to Product in transit caused by any event of any kind by any person (whether or not the Company is legally responsible for the person who caused or contributed to that loss or damage).
- 7.6 The Company shall provide the Buyer with such assistance as may be necessary to press claims on carriers so long as the Buyer:
 - (a) has notified the Company and the carriers in writing immediately after loss or damage is discovered on receipt of Product; and
 - (b) lodges a claim for compensation on the carrier within twenty-four (24) hours of the date of receipt of the Product.

8. ACCEPTANCE OF THE PRODUCT

- 8.1 The Buyer shall be deemed to have accepted the Product upon Delivery of the Product.
- 8.2 After acceptance, the Buyer shall not be entitled to reject Product other than in accordance with these terms and conditions.

9. TITLE AND RISK

- 9.1 Subject to Clauses 9.3 to 9.15, ownership of the goods shall pass on Delivery of the Product.
- 9.2 The Product shall be at the Buyer's risk as from Delivery.
- 9.3 Notwithstanding that Delivery has already been made, property in the Product shall not pass from the Company until:
 - (a) the Buyer shall have paid the Price in full; and
 - (b) no other sums shall be due from the Buyer to the Company.
- 9.4 Until property in the Product passes to the Buyer in accordance with Clause 9.3, the Buyer shall hold the Product on a fiduciary basis as bailee for the Company. The Buyer shall store the Product (at no cost to the Company) separately from all other goods in its possession and marked in such a way that they are clearly identified as the Company's property.
- 9.5 Notwithstanding that the Product remains the property of the Company, the Buyer may sell or use the Product in the ordinary course of the Buyer's business at full market value for the account of the Company. Any such sale or dealing shall be a sale or use of the Company's property by the Buyer on the Buyer's own behalf and the Buyer shall deal as principal when making such sales or dealings. Until property in the Product passes from the Company the entire proceeds of sale or otherwise of the Product shall be held in trust for the Company and shall not be mixed with other money or paid into any overdrawn bank account and shall be at all material times identified as the Company's money.
- 9.6 The Company shall be entitled to recover the Price notwithstanding that property in any of the Product has not passed from the Company.
- 9.7 Until such time as property in the Product passes from the Company, the Buyer shall upon request deliver up such of the Product as has not ceased to be in existence or resold to the Company. If the Buyer fails to do so, the Company may enter upon any premises owned, occupied or controlled by the Buyer where the Product is situated and repossess the Product. On the making of such request, the rights of the Buyer under clause 9.5 shall cease.
- 9.8 The Buyer shall insure and keep insured the Product to the full Price against all risks to the reasonable satisfaction of the Company until the date that property in the Product passes from the Company and shall, whenever requested by the Company, produce a copy of the policy of insurance. Without prejudice to the other rights of the Company, if the Buyer fails to do so, all sums whatever owing by the Buyer to the Company shall immediately become due and payable.
- 9.9 The Buyer acknowledges that these terms and conditions create a security interest under the Personal Property Securities Act 2009 (*Cth*) ("**PPSA**") in all Product previously supplied by the Company to the Buyer (if any) and all Product that will be supplied in the future by the Company to the Buyer.
- 9.10 In this Clause 9, the following words have the respective meanings given to them under the PPSA: accession, account, financing statement, financing change statement, register, registration, security interest and verification statement.
- 9.11 The Buyer must at the Company's request, promptly execute any documents and do anything required to register the Company's security interest in the Product under the PPSA.
- 9.12 The Buyer consents to the Company effecting a registration on the PPSA register (in any manner the Company considers appropriate) in relation to any security interest contemplated by these terms and conditions and the Buyer agrees to provide all assistance reasonably required to facilitate this.
- 9.13 The Buyer must indemnify, and upon demand reimburse, the Company for all expenses incurred in registering a financing statement or financing change statement on the PPSA register.
- 9.14 The Buyer must not without the prior written consent of the Company, assign or in any way grant a security interest in respect of any accounts owed to it relating to the Product which is the property of the Company. Without prejudice to the other rights of the Company, if the Buyer does so, all sums whatever owing by the Buyer to the Company shall immediately become due and payable.
- 9.15 So far as is permitted by the PPSA, the Buyer waives is right:
 - (a) to receive notice of a verification statement or financing change statement in relation to any registration on the PPSA register;
 - (b) to receive any notice required under the PPSA, including a notice that the Company intends to sell the Product or to retain the Product on enforcement of the security interest granted to the Company;
 - (c) to object to a proposal by the Company to retain the Product in satisfaction of any obligation owed by the Buyer to the Company; and
 - (d) where any Product becomes an accession as defined in the PPSA, to not have any goods damaged when the Company removes the accession, to receive notice of

removal of the accession and to apply to the court for an order concerning the removal of the accession, under the PPSA.

10. REMEDIES OF BUYER

- 10.1 Where the Buyer rejects any Product then the Buyer shall have no further rights in respect of the supply to the Buyer of such Product or the failure by the Company to supply Product which conforms to this Sale Agreement.
- 10.2 Where the Buyer accepts or has been deemed to have accepted any Product, the Company shall have no liability whatever to the Buyer in respect of that Product.
- 10.3 The Company shall be under no liability whatever to the Buyer for any indirect loss and/or expense (including loss of profit) suffered by the Buyer arising out of a breach by the Company of this Sales Agreement.
- 10.4 In the event of any breach of this Sales Agreement by the Company, the remedies of the Buyer shall be limited to damages. Under no circumstances shall the liability of the Company exceed the value of the Product.
- 10.5 The Buyer may not withhold payment of any invoice or other amount due to the Company by reason of any right of set-off or counterclaim to which the Buyer may at any time be entitled.
- 10.6 If the Buyer fails to make payment for the Product in accordance with this Agreement or commits any other breach of this Agreement or if a Summons for Winding Up has been filed or a Creditor's Petition has issued against the Buyer or if the Buyer has entered into some other form of insolvency or arrangement or scheme with its creditors whether voluntarily or otherwise, all sums outstanding in respect of the Product shall become immediately payable. The Company may, in its absolute discretion and without prejudice to any other rights which it may have:
 - (a) suspend all future deliveries of Product to the Buyer and/or terminate this Agreement without liability upon its part; and/or
 - (b) exercise any of its rights pursuant to Clauses 9.3 to 9.9 inclusive.

11. REBATES AND ASSOCIATED AGREEMENTS

If the Buyer is a member of more than one buying group and therefore entitle to rebates and associated costs, they must nominate which buying group's terms they wish to apply to their Klingspor account. The Buyer cannot claim more than one rebate or associated costs for the same financial transaction with Klingspor. If the Buyer does not nominate a buying group for the rebate or associated cost, Klingspor will nominate a buying group at its discretion.

12. SEVERANCE

If any provision or part of any provision of this Agreement is or may be void or unenforceable, such invalidity or unenforceability shall be deemed severable and shall not affect any other part of such provision or any other provision of this contract.

13. NO WAIVER

No waiver or forbearance by the Company (whether express or implied) in enforcing this Agreement shall prejudice its right to do so in the future.

14. FORCE MAJEURE

The Company shall not be liable for any default of its obligations under this Agreement due to any act of God, war, strike, lockout, industrial action, fire, flood, drought, tempest or other event beyond its reasonable control.

15. GOVERNING LAW

The parties agree that this Agreement shall be governed by the laws applicable in the State of New South Wales and agree to submit to the jurisdiction of the Supreme Court of New South Wales and any relevant Court of Australian Federal jurisdiction.

Safety

Klingspor products are marked with the oSa label



What does oSa mean?

In a host of applications grinding and cutting require very high peripheral speeds from the rotating abrasive product. These products must therefore be particularly safe so as to stand up to the extreme mechanical and thermal stress.

Regrettably there are no globally binding safety requirements for abrasive products.

This is why responsible manufacturers of abrasive products from a number of European countries set up the Organization for the Safety of Abrasives (oSa) in 2000 and thus setting a clear signal against inferior and dangerous products.

The user recognises these quality grade products from the oSa trade name. They signify to the manufacturer and trader a reduced liability risk, a market and competitive benefit and an image gain.

As a part of their in-house quality management system, the manufacturers see to it that the exact provisions are kept to and that only safe, high quality abrasive products are produced and marketed. The fact that the oSa – Organization for the Safety of Abrasives issues the worldwide protected oSa trademark to members is confirmation of this internal commitment. The oSa label does not mean that the Organization for the Safety of Abrasives or its institutions assume any liability of the designated products.



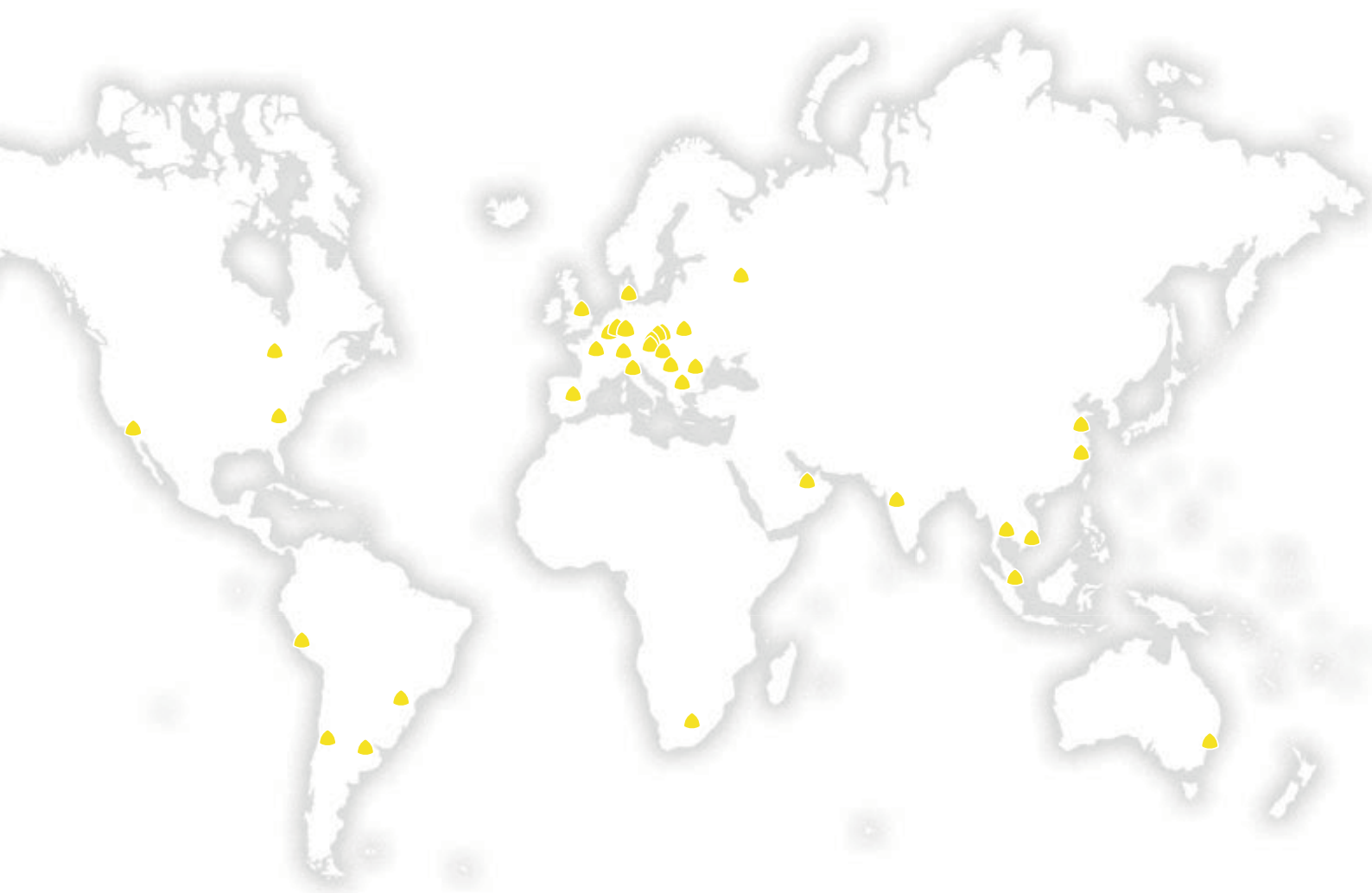

Klingspor N.V. / S.A.
Herent, België / Belgique

Клингспор България ЕООД
София, България

KLINGSPOR Brusivo, spol.sr.o.
Brno, Česká republika

Klingspor A/S
Kolding, Danmark

Klingspor Schleifsysteme GmbH & Co. KG
Haiger, Deutschland

Klingspor Abrasivos S.A.
Alcobendas (Madrid), España

Klingspor S.A.S.
Le Perray en Yvelines, France

Klingspor Abrasives Limited
Worksop, Nottinghamshire
Great Britain

Klingspor S.R.L
Brescia, Italia

Klingspor Magyarország Kft.
Budapest, Magyarország

Klingspor B.V.
Sittard, Nederland

Klingspor Schleifwerkzeuge Gesmbh
Wien, Österreich

Klingspor Sp. z o.o.
Bielsko, Polska

Klingspor Sp. z o.o.
Kozy, Polska

Klingspor România SRL
Pantelimon, Ilfov, România

Клингспор ООО
Москва, Россия

Klingspor d.o.o. Beograd
Beograd, Republika Srbija

Klingspor Suisse GmbH
Bubendorf, Suisse

Клингспор ТОВ
Великі Мости, Львівська обл.,
Україна

Klingspor Inc.
Stoney Creek, Ontario, Canada

Klingspor Abrasivos S.A. de C.V.
Tijuana, Mexico

Klingspor Abrasives, Inc.
Hickory, North Carolina, USA

Klingspor Qingdao Ltd.
Qingdao, P.R. China

Klingspor Abrasive (Shanghai) Co. Ltd.
Shanghai, P.R. China

Klingspor India Private Limited
Pune, India

Klingspor PTE LTD
Singapore, Singapore

Klingspor PTE LTD
Bangkok, Ratcha-anachak Thai

Klingspor Middle East FZCO
Dubai, United Arab Emirates

Klingspor Vietnam Limited
Ho Chi Minh City, Vietnam

Klingspor Argentina SRL
Partido Belén de Escobar,
Argentina

Klingspor Abrasivos Industriais Ltd
Pinhais, Brasil

Comercial Klingspor Chile Ltda.
Pudahuel, Santiago, Chile

Klingspor SAC
Lima, Perú

Klingspor Abrasives South Africa (Pty) Ltd.
Spartan-Kempton Park,
South Africa

Klingspor Australia Pty Ltd
Silverwater, Australia

Klingspor Australia Pty Ltd
P.O. Box 7058
Silverwater
NSW 2128
Tel: +61 2 9737 0597
Fax: +61 2 9737 0598

www.klingspor.com.au

